

Easy! Smooth!

PL-3600 → PS-4600

Replacement Guidebook

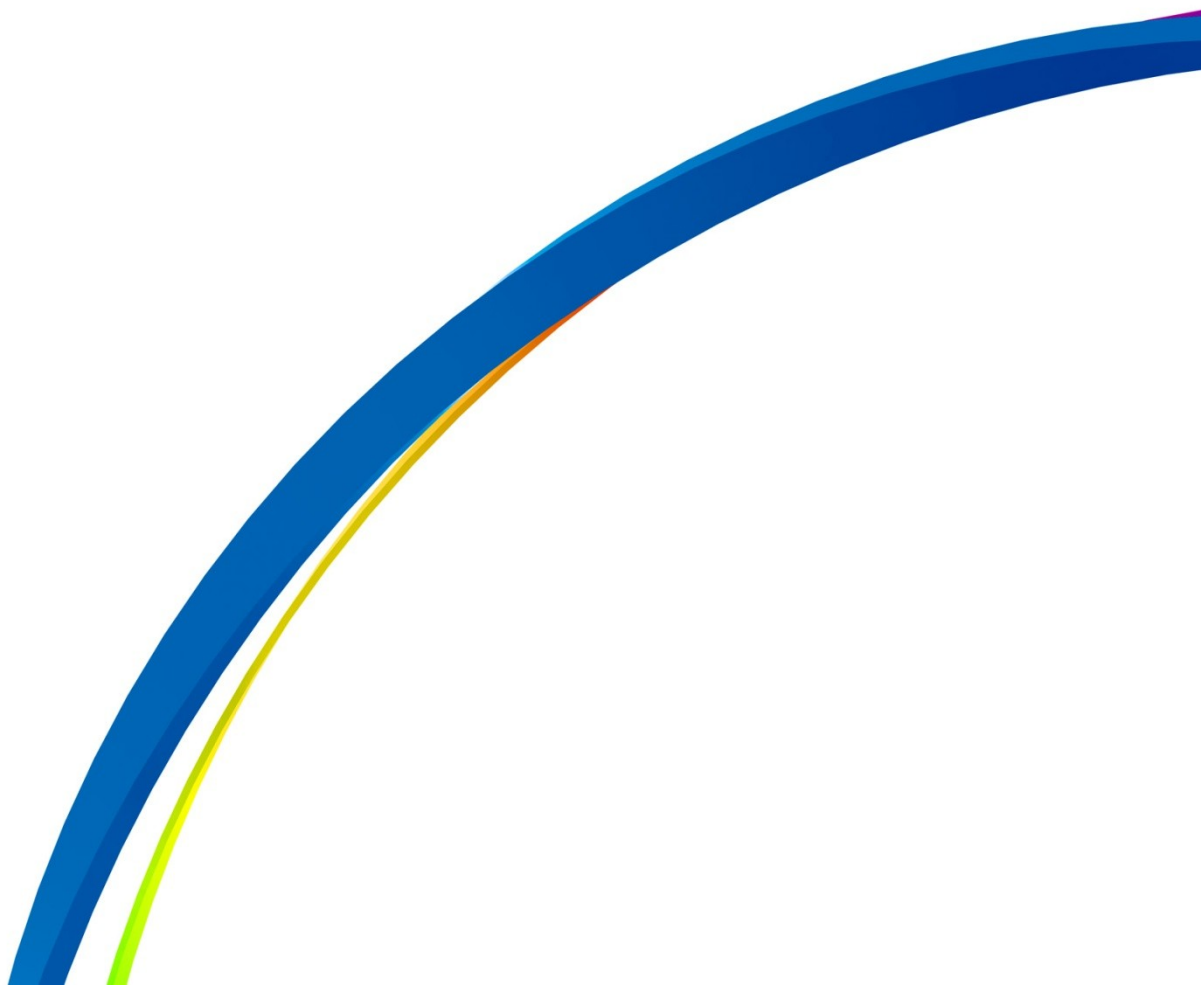

## Introduction

This document introduces the procedures and notes for replacing the PL-3600T with the PS-4600.

The recommended substitute model is listed below.

Equipment in use	Recommended substitute model
<b>PL-3600T *1</b> (2 slots, Core™ Duo model) Model code: APL3600-TA/TD	<b>PS-4600</b> (2 slots, Core™ i3 model) Model code: PFXP*16AE*****N00
<b>PL-3600T *1</b> (2 slots, Celeron® model) Model code: APL3600-TA/TD	<b>PS-4600</b> (2 slots, Celeron® model) Model code: PFXP*16AD*****N00

\*1 Sales terminated as of March 2014

## Interpreting the PS-4600 Series Model Code

A portion of the PS-4600 Series model code differs according to the specification. When purchasing the PS-4600 Series, carefully check the model code to order before making your purchase.

**PFXP** \* 1 \* \* \* \* \* \* \* \* \* \* 0 0  
 5 7 8 9 10 11 12 13 14 15 16

Digit number		5	7	8	9	10	11	12	13	14	15	16
Front bezel	Aluminum Standard Model	P										
	Rear Mount Model	F										
Display	12-inch (XGA)		6									
Expansion slot *1	0 slot			0								
	1 slot = 1 PCI			1								
	1 slot = 1 PCI Express			C								
	2 slots = 1 PCI + 1 PCI Express			2								
	2 slots = 2 PCI			A								
CPU type	Intel® Celeron® M 827E 1.4GHz				D							
	Intel® Core™ i3 3217UE 1.6GHz				E							
Power supply	AC					A						
	DC with interface for UPS Battery Unit					B						
	DC					D						
	AC with interface for UPS Battery Unit					U						
Memory	1GB						1					
	2GB						2					
	3GB(2GB+1GB)						3					
	4GB						4					
	6GB(4GB+2GB)						6					
	8GB						8					
	12GB(8GB+4GB)						C					
	16GB(8GB+8GB)						G					

Digit number		5	7	8	9	10	11	12	13	14	15	16
OS	None							0				
	Windows® Embedded Standard 2009 MUI(32-bit)							1				
	Windows® XP Pro Japanese Version							2				
	Windows® XP Pro MUI							3				
	Windows® Embedded Standard 7 MUI (32-bit)							4				
	Windows® 7 Ultimate MUI (32-bit)							5				
	Windows® 7 Ultimate MUI (64-bit)							6				
Storage	None								N			
	CFast (4GB)								G			
	CFast (8GB)								H			
	CFast (16GB)								J			
	Primary CFast 4 GB + Secondary CFast 4 GB (for Windows® Embedded Standard 2009 MUI)								L			
	Primary CFast 8 GB + Secondary CFast 4 GB (for Windows® Embedded Standard 7 Premium MUI)								M			
	HDD(500GB) with FAN								P			
	SSD(60GB)								T			
	SSD(128GB)								U			
Slide-in Equipment	None									0		
	DVD multi drive									1		
	HDD(500GB)									2		
	SSD(60GB)									3		
Options	None										0	
	COM Expansion Board (RS-232C/422/485)										4	
	COM Expansion Board + COM Expansion Board(RS-232C/422/485)										W	
Software Bundle	None											N
	WinGP											G

\*1 The number in parentheses indicates the number of PCI Express lanes.  
To conform to the PL-3600T, 2 slots are recommended in this document. However, if you are using less PCI slots or have no plans to use the PCI slots when making the replacement, 1 or 0 slot can also be selected.



## Contents

<b>Introduction</b>	<b>2</b>
<b>Interpreting the PS-4600 Series Model Code</b>	<b>3</b>
<b>Contents</b>	<b>5</b>
<b>Chapter 1. Specification Comparison</b>	<b>7</b>
1.1 PL-3600T (Core™ Duo model) and PS-4600 (Core™ i3 model) specification comparison	7
1.2 PL-3600T (Celeron® model) and PS-4600 (Celeron® model) specification comparison	10
<b>Chapter 2. Hardware Compatibility</b>	<b>13</b>
2.1 Differences in function locations	13
2.2 External dimensions	16
2.3 Intelligent fan control	16
2.4 Battery backup UPS	16
2.5 Serial interfaces	16
2.6 USB interface	17
2.7 PCI slots	17
2.8 DVD-RW drive	18
2.9 External HDD, SSD, CFast card, USB devices	18
2.10 Power supply plug	19
2.11 Power consumption	19
<b>Chapter 3. Compatibility with Accessories</b>	<b>20</b>
3.1 Individual accessories	20
3.2 Maintenance accessories	20

<b>Chapter 4. Software Compatibility</b>	<b>21</b>
4.1 Supported operating systems	21
4.2 Supported operating system languages	21
4.3 Supported software	23
4.4 Functions supported by System Monitor	23
<b>Chapter 5. Appendix</b>	<b>24</b>
5.1 FP-3000 Series	24
5.1.1 Connection with the PS-4600	24
5.1.2 Remote installation distances and cables	24
5.1.3 Required touch panel driver	25
5.2 Uninterruptible power supply (UPS)	26
5.2.1 Overview	26
5.2.2 Specifications	27
5.2.3 Dimensions	27
5.3 INtime OS	27

## Chapter 1. Specification Comparison

### 1.1 PL-3600T (Core™ Duo model) and PS-4600 (Core™ i3 model) specification comparison

Display specifications		
	PL-3600T (2 slots, Core™ Duo model)	PS-4600 (2 slots, Core™ i3 model)
		
Display device	TFT color LCD (12-inch)	
Graphics	XGA (1,024 x 768 pixels)	
Display colors/gradation	260,000 colors	<b>UP!</b> 16 million colors
Backlight	<b>Revision "5" with no symbol</b> Cold-cathode tube (replaceable)	LED backlight (not user replaceable, send-back type)
	<b>Revision "5" with symbol</b> LED backlight (not user replaceable, send-back type)	
Brightness adjustment	4 levels (adjust on Windows® control panel)	<b>UP!</b> Step-less adjustment
Display device lifespan	50,000 hours	
Backlight lifespan	50,000 hours or more	
Touch panel	Type	Analog resistive
	Resolution	1,024 x 1,024



Performance specifications		
	PL-3600T (2 slots, Core™ Duo model)	PS-4600 (2 slots, Core™ i3 model)
<b>CPU</b>	Intel® Core™ Duo (2.0 GHz)	<b>UP!</b> Intel® Core™ i3 (1.60GHz)
<b>L2 cache</b>	2 MB	<b>UP!</b> 3 MB
<b>Main memory</b>	2 slots (4 GB max) (DDR2 533 MHz)	<b>UP!</b> 2 slots (16 GB max) (DDR3 1,600MHz)
<b>Chipset</b>	Intel® 945GME + ICH7M	Intel® QM77
<b>Graphics controller</b>	Onboard Intel® 945GME	Intel® HD Graphics 4000
<b>Video memory</b>	64 MB max (Allocated from main memory)	<b>UP!</b> 1 GB (Allocated from main memory)
<b>Video output</b>	<b>Analog</b>	<b>UP!</b> QXGA (2,048 x 1,536 pixels) or lower
	<b>Digital</b>	<b>UP!</b> FHD (1,920 x 1,200 pixels) or lower

General specifications		
	PL-3600T (2 slots, Core™ Duo model)	PS-4600 (2 slots, Core™ i3 model)
<b>Panel cut dimensions</b>	W295.5 x H243.5 mm [W11.63 x H9.59 in.]	W301.5 x H227.5 mm [W11.87 x H8.96 in.]
<b>External dimensions</b>	W338 x H286 x D166 mm [W13.31 x H11.26 x D6.54 in.]	W313 x H239 x D134.5 mm [W12.32 x H9.41 x D5.30 in.] → <a href="#">See 2.2</a>
<b>Front bezel material</b>	Die cast aluminum	Aluminum
<b>Weight</b>	Approx. 8.0 kg (17.64 lbs)	Approx. 4.2 kg (9.26 lbs)
<b>Cooling method</b>	Forced air cooling by fan	<b>UP!</b> Forced air cooling by fan (Intelligent fan control) → <a href="#">See 2.3</a>
<b>Power supply</b> → <a href="#">See 2.10</a>	<b>AC power supply</b>	100 to 240 V
	<b>DC power supply</b>	24 V
<b>Power consumption</b>	<b>AC power supply</b>	145 VA or lower
	<b>DC power supply</b>	145 W or lower
<b>Battery backup UPS</b>	-	<b>NEW!</b> Optional → <a href="#">See 2.4</a>



Interface specifications			
		PL-3600T (2 slots, Core™ Duo model)	PS-4600 (2 slots, Core™ i3 model)
Serial (9-pin D-sub plug)		RS-232C x 2	
		RS-232C/422/485 x 1	RS-232C/422/485 (optional) x 2 →See 2.5
		RS-232C (RI/+5V switchable) x 1	-
RAS		9-pin D-sub socket	-
Disk	SATA	2.5-inch HDD/SSD x 2 (Rev. 1.0a)	<b>NEW!</b> Slide-in disk: (HDD/SSD/CFast adaptor Unit) x 1 Slide-in slot: (HDD/SSD/DVD-RW) x 1 CFast card slot x 1 →See 2.8
	IDE	CF card (Type-I/II, 2 GB) x 1	-
		DVD-ROM/DVD multi-drive (optional)	- →See 2.8
USB →See 2.6		USB x 4 Front USB x 1 (USB 2.0 compatible, Type-A)	USB x 4 (USB 3.0 compatible, Type-A) Front USB x 1 (USB 2.0 compatible, Type-A)
Ethernet	LAN1	10BASE-T/100BASE-TX/1000BASE-T auto switching	
	LAN2	10BASE-T/100BASE-TX auto switching	<b>UP!</b> 10BASE-T/100BASE-TX/1000BASE-T auto switching
Sound		Line output	<b>UP!</b> Line input or mic input / line output
DVI		DVI-I x 1 (For dual output with a front module, analog RGB output only)	DVI-I x 1
PCI		PCI 2 slots (Rev. 2.3)	PCI 2 slots (Rev. 2.2) →See 2.7

1.2 PL-3600T (Celeron® model) and PS-4600 (Celeron® model) specification comparison

Display specifications		
	PL-3600T (2 slots, Celeron® model)	PS-4600 (2 slots, Celeron® model)
		
<b>Display device</b>	TFT color LCD (12-inch)	
<b>Graphics</b>	XGA (1,024 x 768 pixels)	
<b>Display colors/gradation</b>	260,000 colors	<b>UP!</b> 16 million colors
<b>Backlight</b>	<b>Revision "5" with no symbol</b> Cold-cathode tube (replaceable)	LED backlight (not user replaceable, send-back type)
	<b>Revision "5" with symbol</b> LED backlight (not user replaceable, send-back type)	
<b>Brightness adjustment</b>	4 levels (adjust on Windows® control panel)	<b>UP!</b> Step-less adjustment
<b>Display device lifespan</b>	50,000 hours	
<b>Backlight lifespan</b>	50,000 hours or more	
<b>Touch panel</b>	<b>Type</b>	Analog resistive
	<b>Resolution</b>	1,024 x 1,024

Performance specifications		
	PL-3600T (2 slots, Celeron® model)	PS-4600 (2 slots, Celeron® model)
CPU	Intel® Celeron® M 440 (1.86 GHz)	<b>UP!</b> Intel® Celeron® M 827E (1.4 GHz)
L2 cache	1 MB	1.5 MB
Main memory	2 slots (4 GB max) (DDR2 533 MHz)	2 slots (16 GB max) (DDR3 1,600MHz)
Chipset	Intel® 945GME + ICH7M	Intel® HM76
Graphics controller	Onboard Intel® 945GME	Intel® HD Graphics 3000
Video memory	64 MB max (Allocated from main memory)	<b>UP!</b> 1 GB (Allocated from main memory)
Video output	Analog	<b>UP!</b> QXGA (2,048 x 1,536 pixels) or lower
	Digital	<b>UP!</b> FHD (1,920 x 1,200 pixels) or lower

General specifications		
	PL-3600T (2 slots, Celeron® model)	PS-4600 (2 slots, Celeron® model)
Panel cut dimensions	W295.5 x H243.5 mm [W11.63 x H9.59 in.]	W301.5 x H227.5 mm [W11.87 x H8.96 in.]
External dimensions	W338 x H286 x D166 mm [W13.31 x H11.26 x D6.54 in.]	W313 x H239 x D134.5 mm [W12.32 x H9.41 x D5.30 in.] → <a href="#">See 2.2</a>
Front bezel material	Die cast aluminum	Aluminum
Weight	Approx. 8.0 kg (17.64 lbs)	Approx. 4.2 kg (9.26 lbs)
Cooling method	Forced air cooling by fan	<b>UP!</b> Forced air cooling by fan (Intelligent fan control) → <a href="#">See 2.3</a>
Power supply → <a href="#">See 2.10</a>	AC power supply	100 to 240 V
	DC power supply	24 V
Power consumption	AC power supply	145 VA or lower
	DC power supply	145 W or lower
Battery backup UPS	-	<b>NEW!</b> Optional → <a href="#">See 2.4</a>

Interface specifications			
		PL-3600T (2 slots, Celeron® model)	PS-4600 (2 slots, Celeron® model)
Serial (9-pin D-sub plug)		RS-232C x 2	
		RS-232C/422/485 x 1	RS-232C/422/485 (optional) x 2 →See 2.5
		RS-232C (RI/+5V switchable) x 1	-
RAS		9-pin D-sub socket	-
Disk	SATA	2.5-inch HDD/SSD x 2 (Rev. 1.0a)	<b>NEW!</b> Slide-in disk: (HDD/SSD/CFast adaptor Unit) x 1 Slide-in slot: (HDD/SSD/DVD-RW) x 1 CFast card slot x 1 →See 2.8
	IDE	CF card (Type-I/II, 2 GB) x 1	-
		DVD-ROM/DVD multi-drive (optional)	- →See 2.8
USB →See 2.6		USB x 4 Front USB x 1 (USB 2.0 compatible, Type-A)	USB x 4 (USB 3.0 compatible, Type-A) Front USB x 1 (USB 2.0 compatible, Type-A)
Ethernet	LAN1	10BASE-T/100BASE-TX/1000BASE-T auto switching	
	LAN2	10BASE-T/100BASE-TX auto switching	<b>UP!</b> 10BASE-T/100BASE-TX/1000BASE-T auto switching
Sound		Line output	<b>UP!</b> Line input or mic input / line output
DVI		DVI-I x 1 (For dual output with a front module, analog RGB output only)	DVI-I x 1
PCI		PCI 2 slots (Rev. 2.3)	PCI 2 slots (Rev. 2.2) →See 2.7

## Chapter 2. Hardware Compatibility

### 2.1 Differences in function locations

The locations of the various functions differ on the PL-3600T and the PS-4600 as shown below.

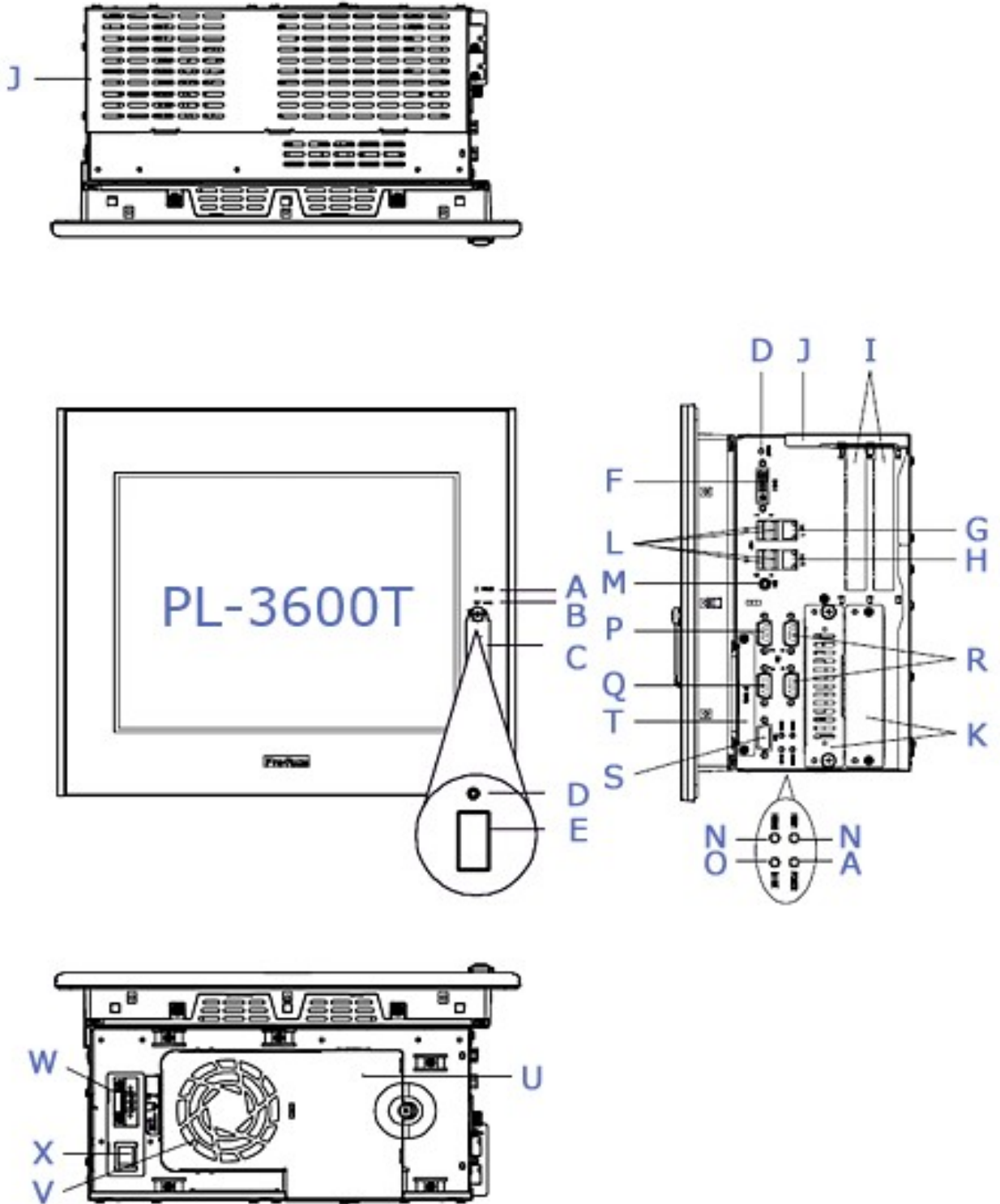

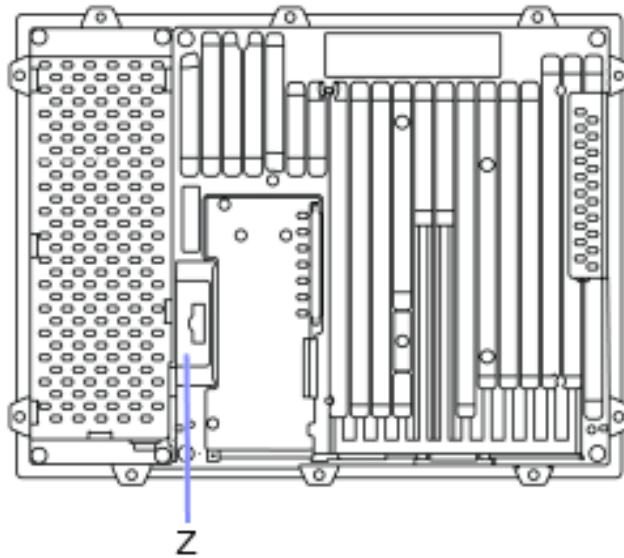
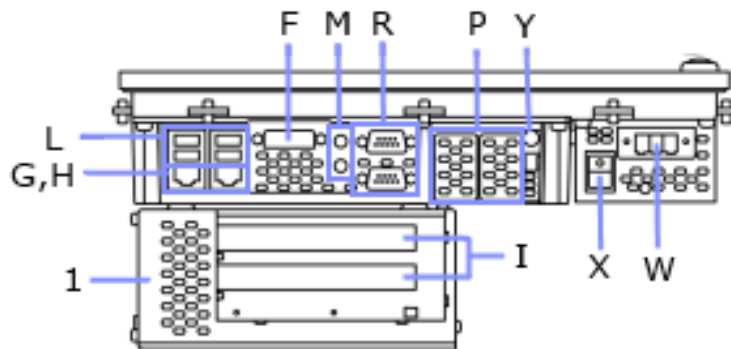
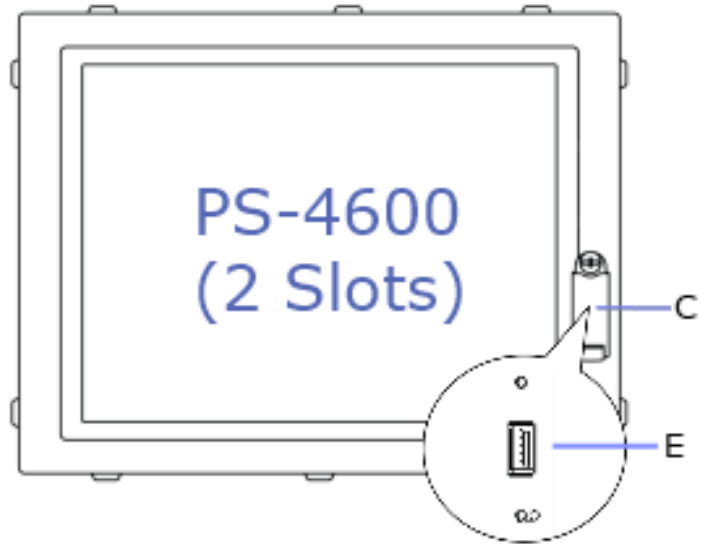
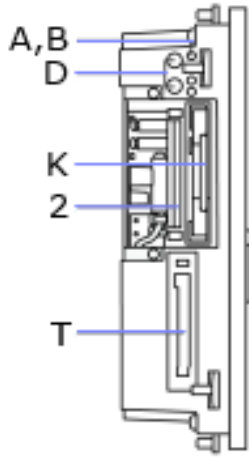
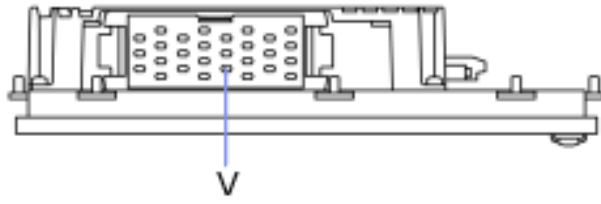

	<b>PL-3600T</b>	<b>PS-4600</b>
A	Power supply LED/RAS status lamp	Status LED
B	IDE access lamp	
C	Front cover	
D	Hardware reset switch	Power/ Reset buttons
E	Front USB interface	
F	DVI-I interface	
G	Ethernet interface (LAN1)	
H	Ethernet interface (LAN2)	
I	Expansion slot (PCI) x 2	
J	PCI slot cover	-
K	HDD slot	Slide-in disk (HDD/SSD/CFast adaptor Unit)
L	USB interface x 4	
M	Speaker output	Line input or mic input / line output
N	HDD status lamp	-
O	Disk access lamp	-
P	Serial I/F (RS-232C/422/485)	Add-on interface module slot x2 (RS-232C/422/485 I/F or UPS I/F)
Q	Serial I/F (RS-232C, RI/5V switchable)	-
R	Serial I/F (RS-232C) x 2	
S	RAS interface	-
T	CF slot	CFast slot/Connection
U	Fan cover	-
V	Cooling fan	Cooling fan (When an HDD is mounted on Slide-in Disk)
W	Power supply connector	
X	Power supply switch (AC model only)	
Y	-	Ground connection
Z	Equipped internally	Backup lithium battery
1	-	Slot expansion and Slide-in Slot (HDD/SSD/DVD-RW)
2	-	Memory Slot

## 2.2 External dimensions

Installation conditions and panel cut size are different between PS-4600 and PL-3600T. A guide to ensure the amount of space necessary to safely install the product is listed below.

	PL-3600T	PS-4600
Vertical, back	<p>Diagram showing the vertical back view of the PL-3600T. It consists of three vertical segments, each labeled 50 [1.97].</p>	<p>Diagram showing the vertical back view of the PS-4600. It features a top and bottom section of 100mm [3.93in.] and a central section of 50mm [1.96in.].</p>
Horizontal	<p>Diagram showing the horizontal view of the PL-3600T. It has a central square area with a side length of 50 [1.97]. The total width is 120 [4.72].</p>	<p>Diagram showing the horizontal view of the PS-4600. It features a central square area with a side length of 10mm [0.39in.] on both the top and bottom edges.</p>

## 2.3 Intelligent fan control

In PS-4600, a fan is attached to the Slide-in Disk when an HDD is mounted. When fanless is required, specify other than "P" for 13<sup>rd</sup> digit of the [model code](#) in the built-in shipping options. When a fan is attached later when an HDD is mounted on the Slide-in Disk, please contact our support division because it is necessary to update the software.

The fan speed for PS-4600 models equipped with a fan is controlled according to the internal temperature. The fan does not operate until the internal temperature reaches a specific temperature.

## 2.4 Battery backup UPS

By equipping the PS-4600 with a UPS battery unit, power can continue to be supplied even when there is a loss of power due to a power failure and running programs can be correctly terminated by the UPS software.

To connect a UPS battery unit, specify "B" or "U" for the 10<sup>th</sup> digit of the [model code](#) in the built-in shipping options.

## 2.5 Serial interfaces

For PS-4600, up to 2 ports of serial interfaces which correspond to a communication method (RS-232/ 422/485) can be added. (When a UPS is selected, only 1 port is added.) In the case of addition, specify "4" or "W" for the 15<sup>th</sup> digit of the [model code](#) in the built-in shipping options.



To perform RS-422/485 communication with the additional serial interface, software is required to switch the RTS lines each time the driver sends or receives data. The RTS lines are not switched automatically.

The PS-4600 also uses COM3 internally as the touch panel interface. When adding additional COM ports with expansion boards or USB-SIO, do not use COM3.

## 2.6 USB interface

The PL-3600T can be configured not to use the front USB port with the DIP switches, but the PS-4600 does not have this setting.

The Rear Mount Model front bezel PS-4600 is not equipped with a USB interface on the front of the touch panel, so there are 4 ports total.

## 2.7 PCI slots

Please note that Compliant bus and Available board size are different between PL-3600T and PS-4600.

	PL-3600T	PS-4600
<b>Compliant bus</b>	Rev.2.3	Rev.2.2
<b>Width(mm[in.])</b>	180[7.09]	177.7[7.0]
<b>Height(mm[in.])</b>	106.68[4.2]	106.7[4.2]

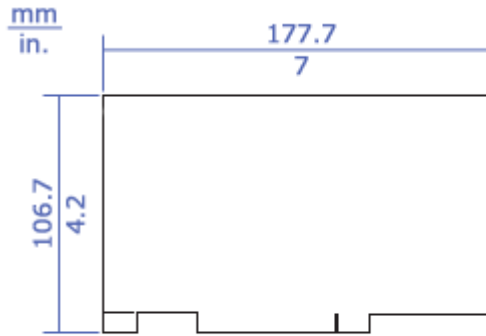

## 2.8 DVD-RW drive

The DVD-RW drive is connected to the slide-in slot. An expansion slot is required for the slide-in slot. Specify other than "0" for 8<sup>th</sup> digit of the [model code](#) in the built-in shipping options. When an HDD or SSD is connected to the slide-in slot, the DVD-RW drive cannot be used. Separately prepare a commercially available DVD drive that can connect via USB.

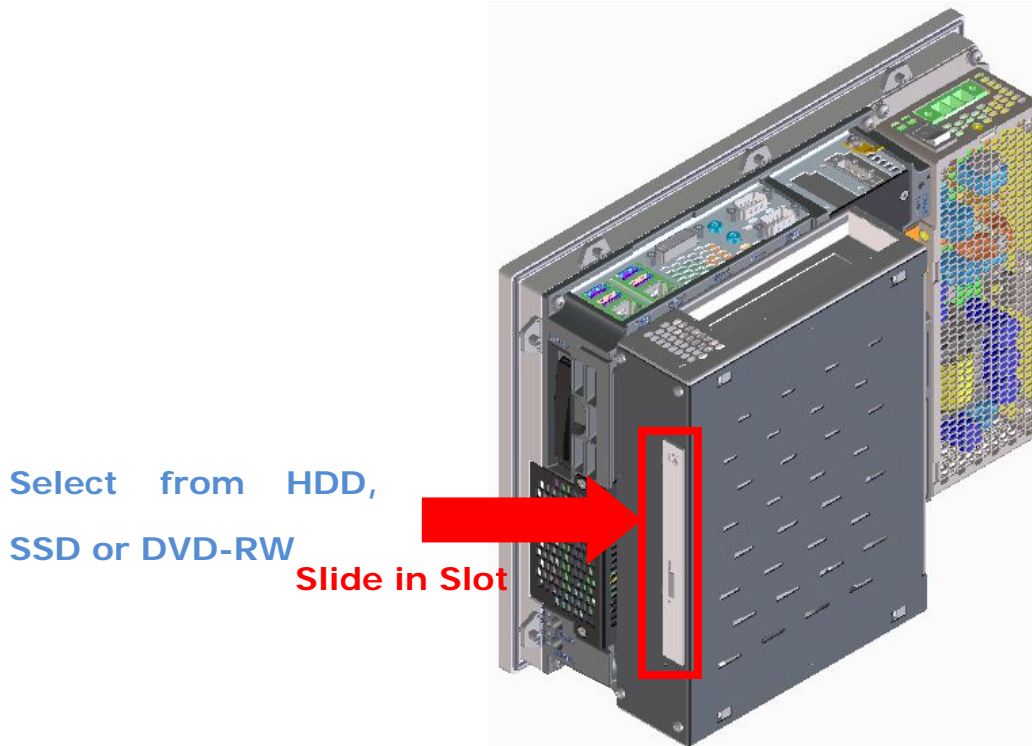

## 2.9 External HDD, SSD, CFast card, USB devices

When an external HDD, SSD, CFast card, or USB device is connected to a PS-4600 pre-installed with Microsoft Windows Embedded Standard, the system will no longer start. In this situation, the system can be made to start with the device connected to it by configuring the setting below in the BIOS boot menu.

Condition	BIOS setting
When using only a CFast card with OS installed	Set [SATA 1 Drive] for the [1st Boot Device] settings.
When using a CFast card with OS installed and another CFast card for storage	Set [SATA 0 Drive] for the [1st Boot Device] settings.

\*The notes above are included with models pre-installed with Microsoft Windows<sup>®</sup> Embedded Standard.

## 2.10 Power supply plug

Caution: The power line terminal locations for the power supply plug differ between the PL-3600T and the PS-4600.

	PL-3600T	PS-4600
AC power supply	<p>Power supply cable</p> <p>AC connector</p> <p>L N FG</p>	<p>AC connector</p> <p>Power supply cable</p> <p>N L FG</p>
DC power supply	<p>Power supply cable</p> <p>DC connector</p> <p>+ 24V - 0V FG</p>	<p>DC connector</p> <p>Power supply cable</p> <p>0V FG 24V</p>

## 2.11 Power consumption

The power consumption does not include the value of power supplied to devices in the provided expansion slots and to USB devices. The maximum power consumption of the entire product including the value of supplied power is 130 W.

## Chapter 3. Compatibility with Accessories

### 3.1 Individual accessories

Individual accessories for the PL-3600T and their compatibility are listed below.

Product name		Model code *	PL-3600T	PS-4600
DIM module DDR2	512 MB	CA7-DDR2-512MB	✓	x
	1 GB	CA7-DDR2-1GB	✓	x
	2 GB	CA7-DDR2-2GB	✓	x
HDD unit	250 GB	APL3000-HD250	✓	x
SSD unit	16 GB	APL3000-SD16	✓	x
CF card	128 MB	CA3-CFCALL/128MB-01	✓	x
	256 MB	CA3-CFCALL/256MB-01	✓	x
	512 MB	CA3-CFCALL/512MB-01	✓	x
	1 GB	CA6-CFCALL/1GB-01	✓	x
	2 GB	CA8-CFCALL/2GB-01	✓	x
Industrial hub		SPIDER8TX-PRO	✓	✓
Software mirroring utility		APL-SM3000	✓	x
USB cable	5 m	FP-US00	✓	✓
RS-232C cable	5 m	FP61V-IS00-O	✓	✓
Analog RGB cable	4.5 m	FP-CV02-45	✓	✓
DVI-RGB conversion cable	5 m	CA7-CBLCVRGB-01	✓	✓
DVI-RGB splitter cable	15 cm	CA7-CBLCVDVI-D/RGB-01	✓	✓
Screen protection sheet (5 pcs.)		CA7-DFS12-01	✓	✓
AC power supply connector (right angle) (5 pcs.)		CA7-ACCNLR-01	✓	x

\* Please check the model code/global code table at <http://www.proface.co.jp/product/globalcode.html>.

### 3.2 Maintenance accessories

Maintenance accessories for the PL-3600T and their compatibility are listed below.

Product name	Model code *	PL-3600T	PS-4600
Replacement battery unit	APL3000-BATTU	✓	x
Drip-proof packing	CA7-WPG12-01	✓	x
Backlight	CA3-BLU12-01	✓	x
Mounting hardware	CA3-ATFALL-01	✓	x
AC power supply connector (straight) (5 pcs.)	CA7-ACCNL-01	✓	x
DC power supply connector (straight) (5 pcs.)	CA7-DCCNL-01	✓	x
AC power supply connector (right angle) (5 pcs.)	CA7-ACCNLR-01	✓	x
DC power supply connector (right angle) (5 pcs.)	CA5-DCCNL-01	✓	x

\* Please check the model code/global code table at <http://www.proface.co.jp/product/globalcode.html>.

## Chapter 4. Software Compatibility

### 4.1 Supported operating systems

The supported operating systems for the PL-3600T and the PS-4600 are listed below.

\* See the bottom of this page for the operating system abbreviations used in this table.

OS	PL-3600T		PS-4600
	Core™ Duo	Celeron® M	
Win2000	✓	✓	×
Win2000 ML	×	✓	×
WinXP	✓	✓	✓
WinXP ML	✓	✓	✓
XPE ML	✓	✓	×
WES2009	×	×	✓
WES7	×	×	✓
Win7	×	×	✓

### 4.2 Supported operating system languages

The supported operating system languages differ between the PS-4600 and the PL-3600T. They are listed in the table on the following page.

\* The abbreviations and symbols in the table have the following meanings.

✓	Supported.
Δ	The language can be used by installing the language pack provided with "Otasuke Pro!". Download from the URL below. <a href="http://www.proface.co.jp/otasuke/download/ps/ps4000/wes7lang.htm">http://www.proface.co.jp/otasuke/download/ps/ps4000/wes7lang.htm</a>
x	Not supported.
Win2000	Windows® 2000 Japanese
Win2000 ML	Windows® 2000 Multi-Language
WinXP	Windows® XP Professional Japanese
WinXP ML	Windows® XP Professional Multi-Language
XPE ML	Windows® XP Embedded Multi-Language
WES2009	Windows® Embedded Standard 2009
WES7	Windows® Embedded Standard 7
Win7	Windows® 7 Ultimate
3600T	PL-3600T
4600	PS-4600

Language	WinXP		WinXP ML		XPE ML	WES 2009	WES7	Win7
	3600T	4600	3600T	4600	3600T	4600	4600	4600
Arabic	x	x	x	✓	Δ	✓	Δ	✓
Bulgarian	x	x	✓	✓	x	x	Δ	✓
Chinese (Simplified)	x	x	✓	✓	Δ	✓	Δ	✓
Chinese (Traditional)	x	x	✓	✓	Δ	✓	Δ	✓
Croatian	x	x	✓	✓	x	x	Δ	✓
Czech	x	x	✓	✓	Δ	✓	Δ	✓
Danish	x	x	✓	✓	Δ	✓	Δ	✓
Dutch	x	x	✓	✓	Δ	✓	Δ	✓
English	x	x	✓	✓	✓	✓	✓	✓
Estonian	x	x	✓	✓	x	x	Δ	✓
Finnish	x	x	✓	✓	Δ	✓	Δ	✓
French	x	x	✓	✓	✓	✓	✓	✓
German	x	x	✓	✓	✓	✓	✓	✓
Greek	x	x	✓	✓	Δ	✓	Δ	✓
Hebrew	x	x	x	✓	Δ	✓	Δ	✓
Hungarian	x	x	✓	✓	Δ	✓	Δ	✓
Italian	x	x	✓	✓	✓	✓	✓	✓
Japanese	✓	✓	x	✓	✓	✓	✓	✓
Korean	x	x	x	✓	Δ	✓	Δ	✓
Latvian	x	x	✓	✓	x	x	Δ	x
Lithuanian	x	x	✓	✓	x	x	Δ	✓
Norwegian	x	x	x	✓	Δ	✓	Δ	✓
Polish	x	x	✓	✓	Δ	✓	Δ	✓
Portuguese	x	x	✓	✓	Δ	✓	Δ	✓
Portuguese (Brazil)	x	x	✓	✓	Δ	✓	Δ	✓
Romanian	x	x	✓	✓	x	x	Δ	✓
Russian	x	x	✓	✓	Δ	✓	Δ	✓
Serbian Latin	x	x	x	x	x	x	Δ	✓
Slovak	x	x	✓	✓	x	x	Δ	✓
Slovenian	x	x	✓	✓	x	x	Δ	✓
Spanish	x	x	✓	✓	✓	✓	✓	✓
Swedish	x	x	✓	✓	Δ	✓	Δ	✓
Thai	x	x	✓	✓	x	x	Δ	✓
Turkish	x	x	✓	✓	Δ	✓	Δ	✓
Ukrainian	x	x	x	x	x	x	Δ	✓

### 4.3 Supported software

The software that the PS-4600 supports is listed below.

Software	Software mirroring (APL-SM3000)	x
	WinGP *1	✓
Utilities	System Monitor	✓
	Touch panel driver *2	✓
	Keyboard emulator *3	✓
	Remote shutdown	x
	EWF Setting Tool *4	✓
	XP Embedded CF card backup/recovery tool *5	x
	Lang Shell *6	x
API-DLL *8	Language selection Shell update *7	✓
	System Monitor	x
	EWF	x

\*1 When WinGP was installed on the PL-3600T and RS-422/485 communication was being performed, the PL-3600T cannot be replaced with the PS-4600 as is.

→See 2.5

\*2 The PL-3600T driver is DMC's UPDD, but the PS-4600 uses software called Touch Screen.

Please be aware that right click operations change to touch and hold.

The touch sound is also issued when the finger is lifted from the screen, not when the screen is pressed.

\*3 Use the user assistance screen keyboard standard in Windows® 7 Ultimate and Windows® Embedded Standard 7.

\*4 The PL-3600T was RAM mode, but the PS-4600 changes to RAM REG.

\*5 The PL-3600T had a dedicated tool, but the PS-4600 does not support it.

When backup/recovery is required, prepare a normal tool (commercially available product, free software).

\*6 Can be configured with the Windows® Embedded Standard 7 standard function.

\*7 Only supported by Windows® Embedded Standard 7.

\*8 API-DLL is not supported.

### 4.4 Functions supported by System Monitor

The System Monitor functions that the PS-4600 supports are listed below.

Monitor item	Error Action	
Voltage	DOUT	x
	LED	x
	Buzzer	x
	Popup Message	x
	Shutdown	x
Fan *1	DOUT	x
	LED	✓
	Buzzer	✓
	Popup Message	✓
	Shutdown	✓
Temperature	DOUT	x
	LED	✓
	Buzzer	✓
	Popup Message	✓
	Shutdown	✓
Backlight	DOUT	x
	LED	x
	Buzzer	x
	Popup Message	x
	Shutdown	x
Watchdog Timer	DOUT	x
	LED	x
	Buzzer	x
	Popup Message	x
	Shutdown	x
	Hardware Reset	x

Monitor item	Error Action	
SMART	DOUT	x
	LED	✓
	Buzzer	✓
	Popup Message	✓
DIN	DOUT	x
	LED	x
	Buzzer	x
	Popup Message	x
	Shutdown	x
Remote Reset	-	x
Remote RAS	-	x
Battery	DOUT	x
	LED	x
	Buzzer	✓
	Popup Message	✓
	Shutdown	✓
	Shutdown Time	0-60 Sec

\*1 Only when an HDD is mounted on the slide-in Disk.

## Chapter 5. Appendix

### 5.1 FP-3000 Series

#### 5.1.1 Connection with the PS-4600

The PS-4600 can connect to the FP-3000 Series by DVI\* or analog RGB. PS-4600 images can also be output to a separate location.

\* Its Rev.2 or later of FP3000 Series supports DVI

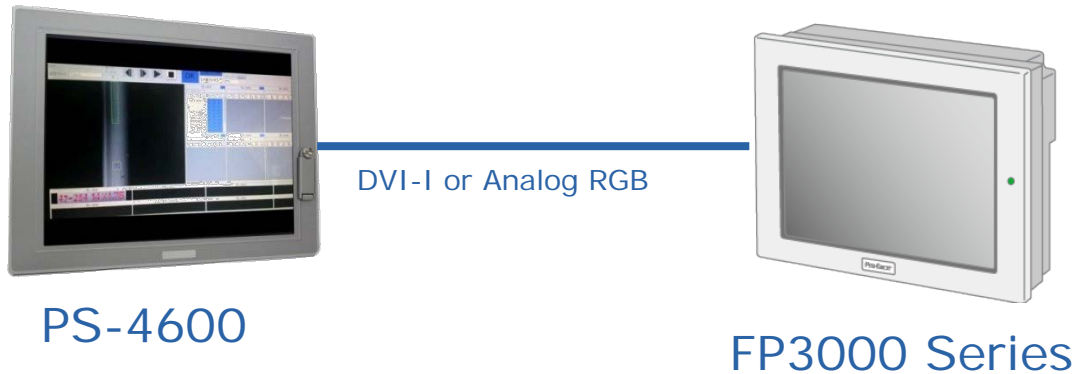

#### 5.1.2 Remote installation distances and cables

The distances the FP-3000 Series can be remotely installed and the cables that support those distances are listed below.

Cable		Model code
5 m	Analog RGB	CA7-CBLCVRGB-01 or CA7-CBLCDVI-D/RGB-01 + FP-CV02-45
	DVI	FP-DV01-50 *1
	USB	FP61V-IS00-O or FP-US00
10 m	DVI	PFXZPBCBDV101 *2

\*1 To connect the FP-3000 Series to the PS-4000 Series, only revision "2" FPs with the symbol can be used.

\*2 The maximum cable length for DVI standard is 5m. Because the 10m cable is non-standard, the exact performance is not guaranteed. According to environment or equipment configuration, video images may not be displayed properly, so be sure to check performances every time environment or equipment configuration is changed. A 5m cable is recommended when using in SXGA resolution or higher.



### 5.1.3 Required touch panel driver

The required touch panel driver for each monitor is listed below.

OS	PS-4000 Series	FP-3000 Series		
	PS-4600	FP-3710T	FP-3710K/FP-3900T	FP-3600T *1/ FP-3650T
WinXP JP, WinXP ML, WES2009	Touch Screen	UPDD		
Win7, WES7		TSC-DD		

\*1 Win7 and WES7 do not officially support a SVGA (800 x 600 pixels) resolution, but we have verified that the screen is displayed without problems.

WinXP JP	Windows® XP Professional Japanese
WinXP ML	Windows® XP Professional Multi-Language
WES2009	Windows® Embedded Standard 2009
WES7	Windows® Embedded Standard 7
Win7	Windows® 7 Ultimate

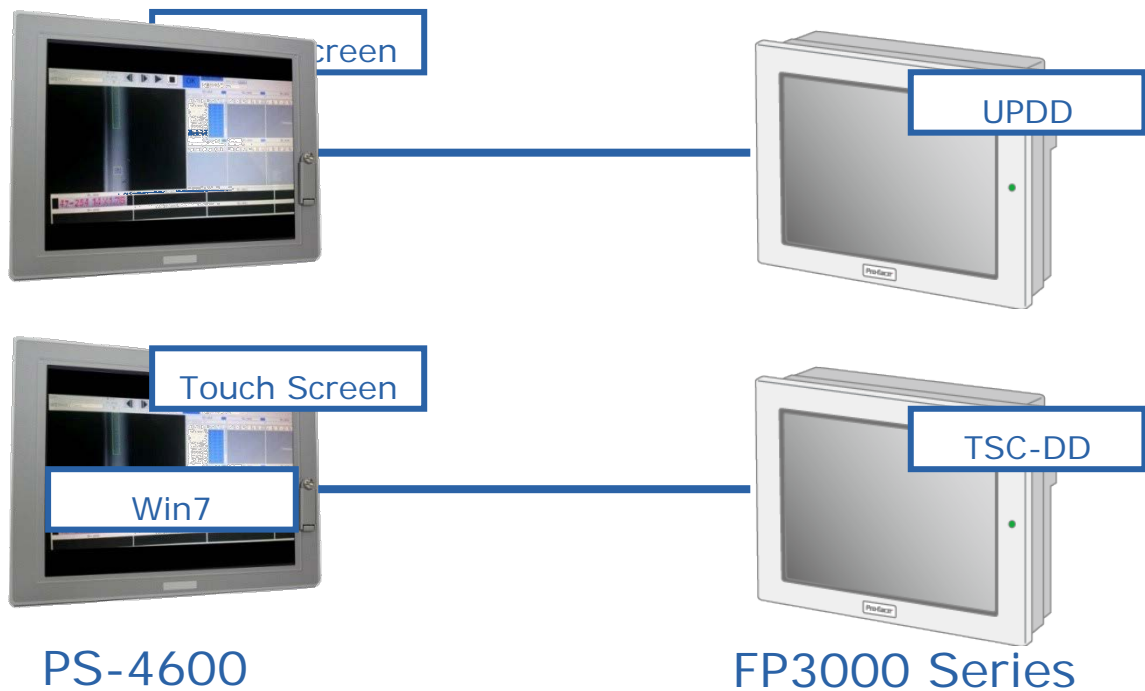

## 5.2 Uninterruptible power supply (UPS)

### 5.2.1 Overview

An uninterruptible power supply (UPS) option can be used for both AC and DC power supply type. The diagram below shows PS4600 with the UPS attached. Attach a UPS I/F board to an IF 1 of an expansion interface module.

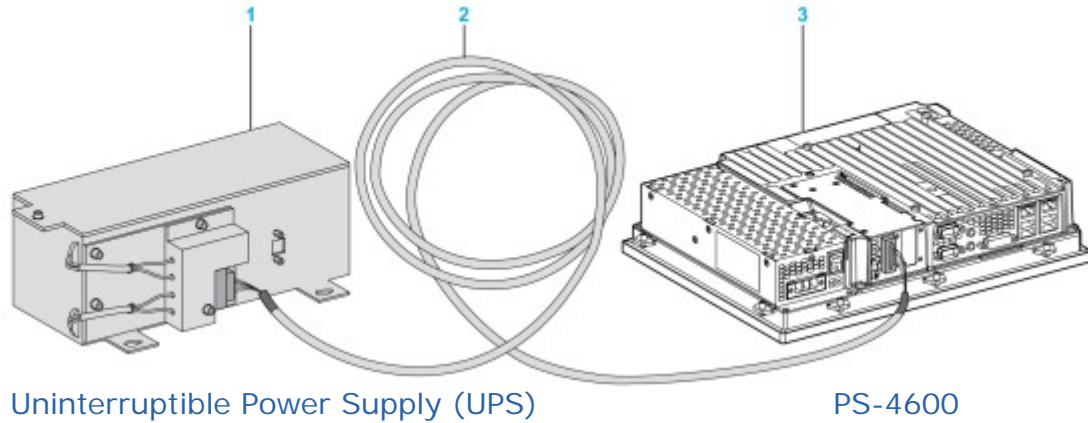

1: UPS battery unit (model code: PFXZPSEUUPB2)

2: UPS connection cable 3 m (model code: PFXZPSCBUP32)

3: PS-4600 Series equipped with the UPS interface board (model code: PFXZPSIUUPM2\*)

Primary features of the UPS option:

- Rechargeable battery that is maintenance free and lasts a long time
- Communication over the built-in interface
- Temperature sensor
- Over discharge protection

\* You must specify "B" or "U" for the 10<sup>th</sup> digit of the [model code](#) in the built-in shipping options. It is possible for a user to purchase an UPS as an option and attach it to the main unit later.

### 5.2.2 Specifications

Battery: Type Method	Hawker Cyclon 12 Vdc 4.5 Ah (2 connected in series) Single cell (X cell)
Rated Voltage	24 Vdc
Battery Charging Current	2.88 A maximum
Deep discharge protection	Yes
Short circuit protection	Yes (This does not apply to the connected battery unit.)
Power consumption	15.0 W maximum at 0.5A
Status indicator	Displayed in System Monitor utility
Configuration	Configured with System Monitor utility

### 5.2.3 Dimensions

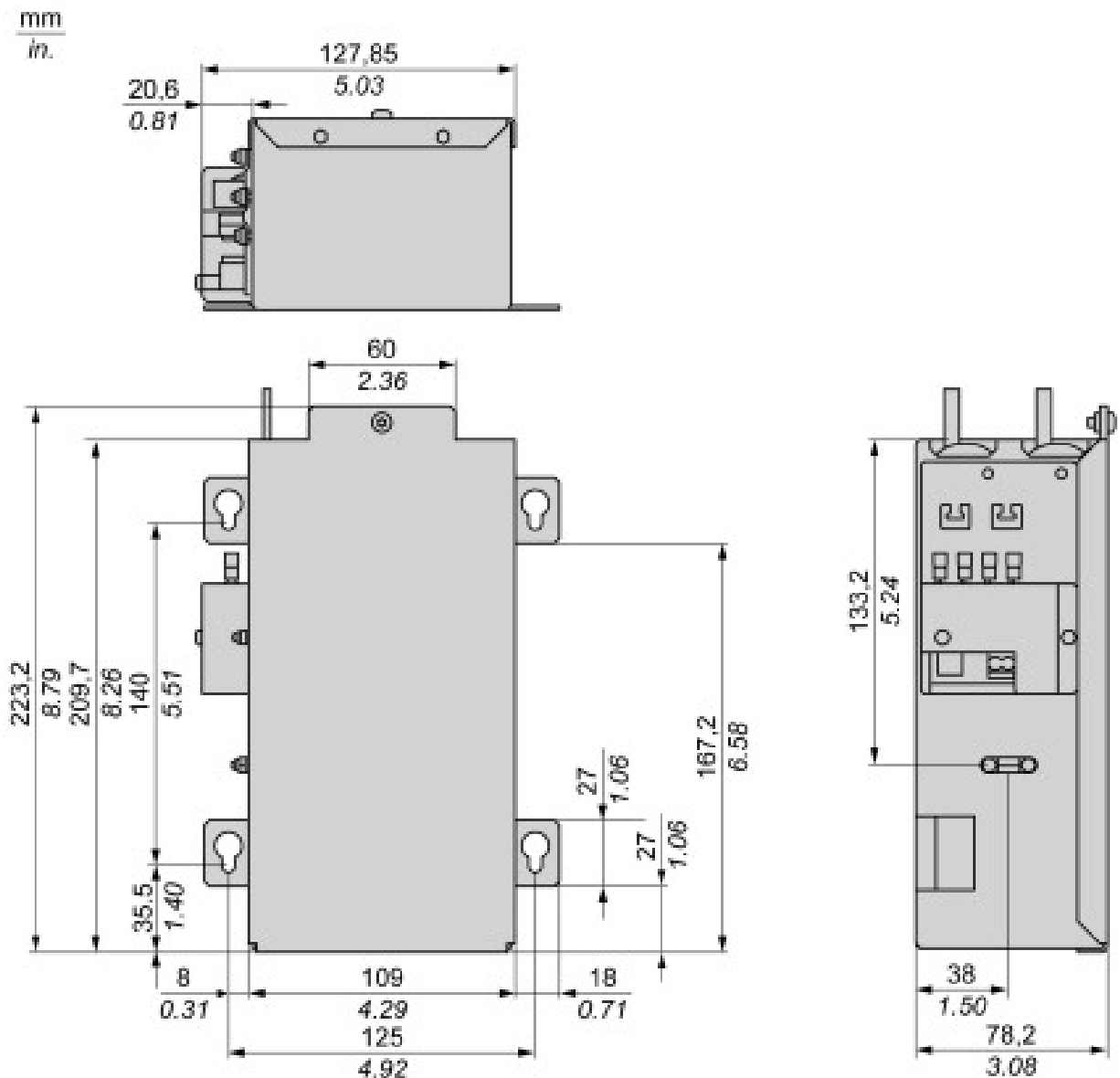

### 5.3 INtime OS

PS-4600 is scheduled to support the INtime OS.

For details, contact TenAsys Corporation.

<http://www.mnc.co.jp/INtime/>

<http://www.tenasys.com/products/intime.php>