

Preface

Thank you for purchasing Digital's GP-377R Series Multi Unit (hereafter referred to as the "Multi Unit"). This Multi Unit is installed to the Graphic Control Panel <Pro-face> GP-377R Series (hereafter referred to as the "GP") and enables data input from/output to a CF card, as well as printer output from the GP. In addition, via the Multi Unit's Ethernet connector, the GP can be connected to an Ethernet network via a 10BASE-T interface.

This manual describes how to install the Multi Unit, and use it correctly and safely with the GP. Also, individual manuals have been prepared to explain the use of each GP. Therefore, be sure to first read "Chapter 1-1 Prior to Operating the GP" in your GP's User Manual (sold separately).

<Note>

- 1) It is forbidden to copy the contents of this manual, in whole or in part, except for the user's personal use, without the express permission of the Digital Electronics Corporation of Japan.
- 2) The information provided in this manual is subject to change without notice.
- 3) This manual has been written with care and attention to detail; however, should you find any errors or omissions, please contact Digital Electronics and inform them of your findings.
- 4) Be aware that the Digital Electronics Corporation shall not be held liable for any real or estimated damages or losses, or third party claims resulting from the use of this product.
- 5) The GP377R-MLTE41 is UL/c-UL(CSA) approved and CE marked. However, installing this unit in a GP unit that is not UL/c-UL(CSA) approved and CE marked will cause the this unit to lose its UL/c-UL(CSA) approval and CE marking.

© Copyright 2000, Digital Electronics Corporation. All rights reserved.

All product names mentioned in this manual are the registered trademarks of those companies.

Table of Contents

Preface	E-i
Table of Contents	E-ii
Essential Safety Precautions	E-iv
UL/c-UL(CSA) Application Notes	E-vi
CE Marking Notes	E-vi
Package Contents	E-vii
Optional Items.....	E-vii
Compatible Models	E-viii
Documentation Conventions	E-viii

Chapter 1 Introduction

1.1 Multi Unit Features	E1-1
1.2 System Configuration	E1-2
1.3 Network Configuration	E1-3
1.3.1 Screen Creation Software Settings	E1-3

Chapter 2 Specifications

2.1 Multi Unit Specifications	E2-1
2.1.1 General Specifications	E2-1
2.1.2 External Specifications	E2-1
2.1.3 Interface Specifications	E2-2
2.2 Interface Connector Specifications	E2-3
2.2.1 Printer Interface	E2-3
2.3 Component Names and Functions	E2-4
2.4 External Dimensions	E2-5

Chapter 3 Installation and Setup

3.1 Installing the Multi Unit	E3-1
3.2 CF Card Insertion and Removal	E3-2
3.3 Printer Setup.....	E3-4

Preface

Chapter 4 CF Card

4.1 CF Card Handling E4-1
4.2 CF Card Initialization E4-3
4.3 Screen Data Backup E4-5

Chapter 5 Maintenance

5.1 Troubleshooting..... E5-1
 5.1.1 Ethernet Troubleshooting E5-2
5.2 Self-Diagnosis E5-4

Index

Essential Safety Precautions

This manual includes procedures that must be followed to operate the Multi Unit and GP correctly and safely. Be sure to read this manual and any related materials thoroughly to understand the correct operation and functions of the Multi Unit and GP.

■ Symbol Meanings

To indicate the correct use of the Multi Unit and GP, the following symbols are provided throughout this manual, to indicate operations or procedures requiring special attention. The following is an example of these symbols and their meanings:



Incorrect operation resulting from negligence of this instruction may cause death or serious injury.

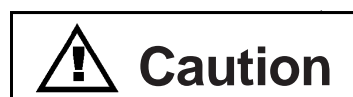

Incorrect operation resulting from negligence of this instruction may cause injury or damage to equipment.

WARNINGS

When using the Multi Unit and GP, follow the precautions below:

- **Prior to installing and wiring the Multi Unit, confirm that GP's power is OFF. Otherwise, an electric shock can occur.**
- **NEVER attempt to modify or re-design the Multi Unit, since it can cause a fire or an electric shock.**

CAUTIONS

When using the Multi Unit and the GP, be sure to follow the precautions listed below:

- Be sure not to touch the inner face of the Multi Unit's circuit board.
- Prior to inserting or removing a CF Card, be sure to turn the Multi Unit's CF Card ACCESS switch OFF and to confirm that the ACCESS lamp is not lit. If you do not, CF Card internal data may be destroyed.
- While a CF Card is being accessed, NEVER turn OFF or reset the GP, or insert or remove the CF Card. Prior to performing these operations, create and use a special GP application screen that will prevent access to the CF Card.

Reference Refer to *GP-PRO/PB III for Windows Tag Reference Manual* (included in the screen editor software package)

- Be sure to use only CF Cards manufactured by the Digital Electronics Corporation. Multi Unit performance cannot be guaranteed when using another manufacturer's CF Card.
- Once GP data is lost, it cannot be recovered. Since accidental data loss can occur at any time, be sure to back up all GP screen and CF card internal data regularly.

■ To Prevent a Multi Unit Malfunction or Internal Damage:

- Be sure that water, liquids, or metal particles do not enter the Multi Unit, since it may cause the unit to malfunction, or may cause an electric shock.
- DO NOT store the Multi Unit in a place where it will be exposed to direct sunlight, high temperatures, excessive dust, or vibration.
- The Multi Unit is precision equipment. DO NOT subject it to excessive shocks.
- DO NOT store the Multi Unit near chemicals, or where chemicals can come into contact with the unit.
- DO NOT use thinner or organic solvents to clean the metal cover of the Multi Unit. When this cover becomes dirty or smudged, moisten a soft cloth with diluted neutral detergent, wring the cloth well, and wipe the cover. NEVER wipe the Multi Unit's internal circuit board.
- DO NOT touch the Multi Unit's internal circuit board when handling the unit.

UL/c-UL(CSA) Application Notes

The GP377R-MLTE41 is a UL/c-UL(CSA) listed product. (UL file No.E182139)

This unit conforms as a product to the following standards:

◆ **UL508**

Industrial Control Equipment

◆ **UL1604**

Electrical Equipment for use in Class I and II, Division 2 and Class III Hazardous Location, industrial control applications.

◆ **CAN/CSA-Nos. 142, and 213-M1987**

Standard for Safety of Information Technology Equipment, including Electrical Business Equipment.

GP377R-MLTE41 (UL Registration Model: 2880048)

<Cautions>

- When the Multi Unit is installed in a GP unit, the combination of the GP and the Multi Unit must be re-evaluated to receive UL/c-UL approval.
- Be sure that this unit is mounted at least 100 mm (3.94 in.) away from any adjacent structures or equipment. If these requirements are not met, the heat generated by the unit's internal components may cause the unit to fail to meet UL/c-UL(CSA) standard requirements.

UL1604 Compliance Conditions and Handling Cautions:

1. Power, input and output (I/O) wiring must be in accordance with Class I, Division 2 wiring methods - Article 501- 4(b) of the National Electrical Code, NFPA 70 within the United States, and in accordance with Section 18-152 of the Canadian Electrical Code for units installed within Canada and in accordance with the authority having jurisdiction.
2. Suitable for use in Class I, Division 2, Groups A, B, C and D hazardous or non-hazardous locations only.
3. WARNING: Explosion hazard - substitution of components may impair suitability for Class I, Division 2.
4. WARNING: Explosion hazard - when in hazardous locations, turn power OFF before replacing or wiring modules.
5. WARNING: Explosion hazard - do not disconnect equipment unless power has been switched OFF, or the area is known to be non-hazardous.

CE Marking Notes

The GP377R-MLTE41 is a CE marked product that conforms to EMC directives EN55011 Group1 Class A and EN50082-2.

For detailed CE marking information, contact the Digital Electronics Corporation.

Package Contents

The Multi Unit's packing box contains the items listed below. Please check to confirm that all items shown below have been included.

■ **Multi Unit**

- GP377R-MLTE11(Standard unit)
- GP377R-MLTE41 *1
(UL/c-UL(CSA),CE marked unit)

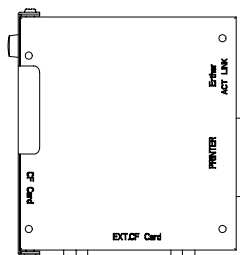

■ **GP-377R Series Multi Unit User Manual (this manual)**

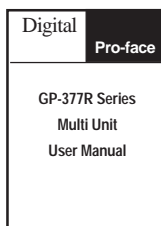

■ **Attachment Screws (4)**

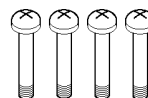

■ **Attachment Screw Washers (4)**



■ **Attachment Screw Lock Washers (4)**



This unit has been carefully packed, with special attention to quality. However, should you find anything damaged or missing, please contact your local GP distributor immediately for prompt service.

Optional Items

The following items are optionally available for the Multi Unit:

- | | |
|----------------------------------|--------------|
| ■ CF card (8MB) | GP077-CF10 |
| (16MB) | GP077-CF20 |
| ■ CF card adapter | GP077-CFAD10 |
| ■ CF card front maintenance unit | GP070-CFFM10 |

**1 The GP377R-MLTE41 is UL/c-UL(CSA) approved and CE marked. However, installing this unit in a GP unit that is not UL/c-UL(CSA) approved and CE marked will cause the this unit to lose its UL/c-UL(CSA) approval and CE marking.*

Compatible Models

The Multi Unit is designed to be used with the following products:

■ Compatible GP Units

All GP-377R Series Units



- GP377R-TC11-24V (Standard Units)
- GP377R-TC41-24V (UL/c-UL(CSA),CE marked unit)

■ Compatible Software

- GP-PRO/PB III for Windows Version 4.0 or higher
- Pro-Server with Pro-Studio for Windows Version 2.0 or higher

Documentation Conventions

This manual uses the following symbols and terminology.

Multi Unit	Indicates GP-377R Series Multi Unit.
GP	Indicates GP-377R Series.
GP Screen Editor	Indicates the GP-PRO/PBIII for Windows Ver. 4.0 or later screen editor software.
*1	Indicates useful or important supplemental information.
	Provides useful or important supplemental information.
	Refers to useful or important supplemental information.

Chapter

1 Introduction

1. Multi Unit Features
2. System Configuration
3. Network Configuration

This chapter describes the Multi Unit's functions.

1.1 Multi Unit Features

Using a Multi Unit allows you to perform data input/output from a GP unit to a CF card, as well as print out data from a GP unit.

For the detailed information about the CF card, refer to the screen editor software's manual.

Reference Refer to *GP-PRO/PB III for Windows Tag Reference Manual* (contained in the screen editor software package).

Since the Multi Unit is equipped with a 10BASE-T interface, your GP unit can be connected directly to an Ethernet-compatible PLC or to a personal computer.

Installing this unit in a GP and then connecting it to an Ethernet network allows the user to exchange their PLC and GP data with a host (PC). Also, the same Ethernet network can be used to exchange data with and collect data from other PLCs on the network.

These features allow you to easily create applications for data collection and exchange.

For information about the 2-Way driver feature,

Reference Refer to *Pro-Server with Pro-Studio for Windows Operation Manual* (contained in the Pro-Server with Pro-Studio for Windows software package)



- To use the Multi Unit, the software "GP-PRO/PB III for Windows Version 4.0" or higher is required.
- To use the 2-way driver, the software "Pro-Server with Pro-Studio for Windows Version 2.0" or higher is required.

1.2 System Configuration

The following is an example of the entire system configuration when using the Multi Unit.

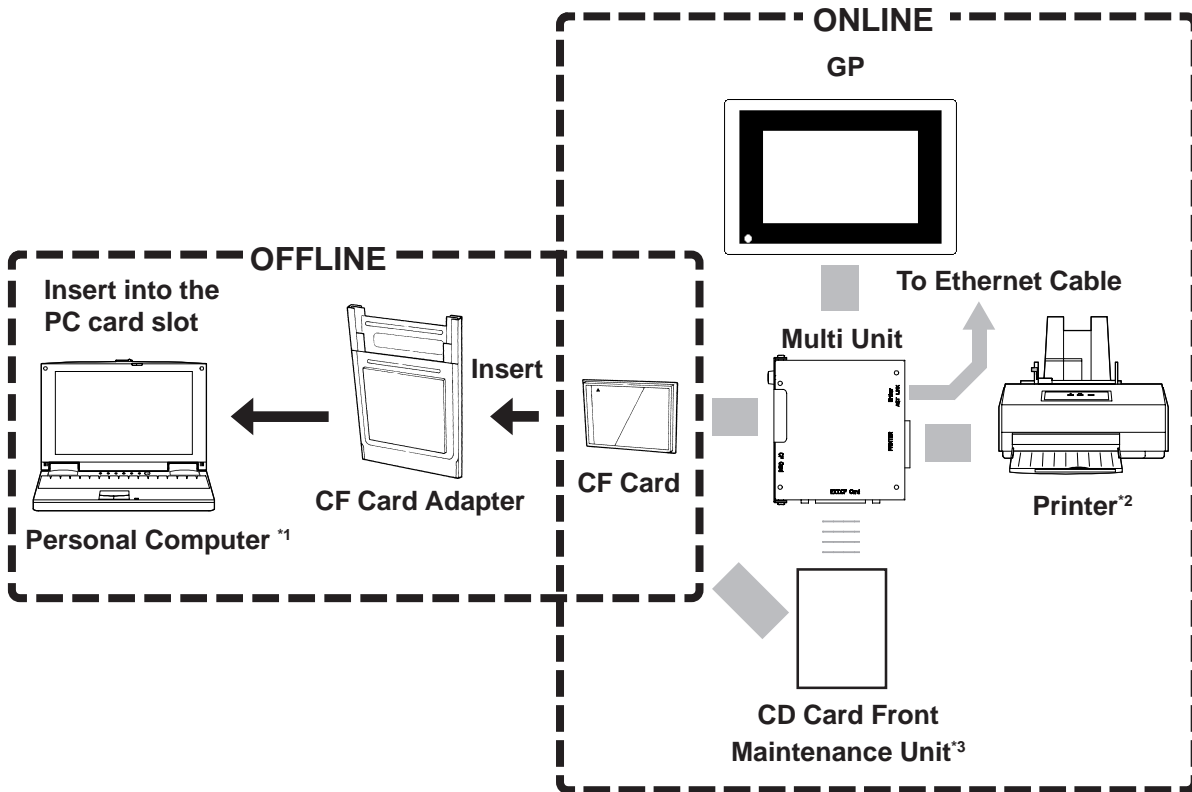

**1 A personal computer running Windows 95/98/NT 4.0 can operate is recommended.*

**2 A dedicated Windows printer cannot be used. A printer that recognizes HP Laser Jet PCL 4 commands, NEC PR 201 PL commands, and EPSON ESC/P24-84 commands, or commands equivalent to these models can be used. Even if a printer is not one of these models, if it has both Windows and DOS drivers, it may be able to be used. For the detailed information, please contact your local GP distributor.*

**3 When the CF Card Front Maintenance Unit is attached, the Multi Unit's CF Card Interface cannot be used.*

1.3 Network Configuration

The Ethernet network should be created using 10BASE-T. The following is an example connection layout:

Interface Specifications

Data transmission type: IEEE802.3

Data transmission speed: 10Mbps

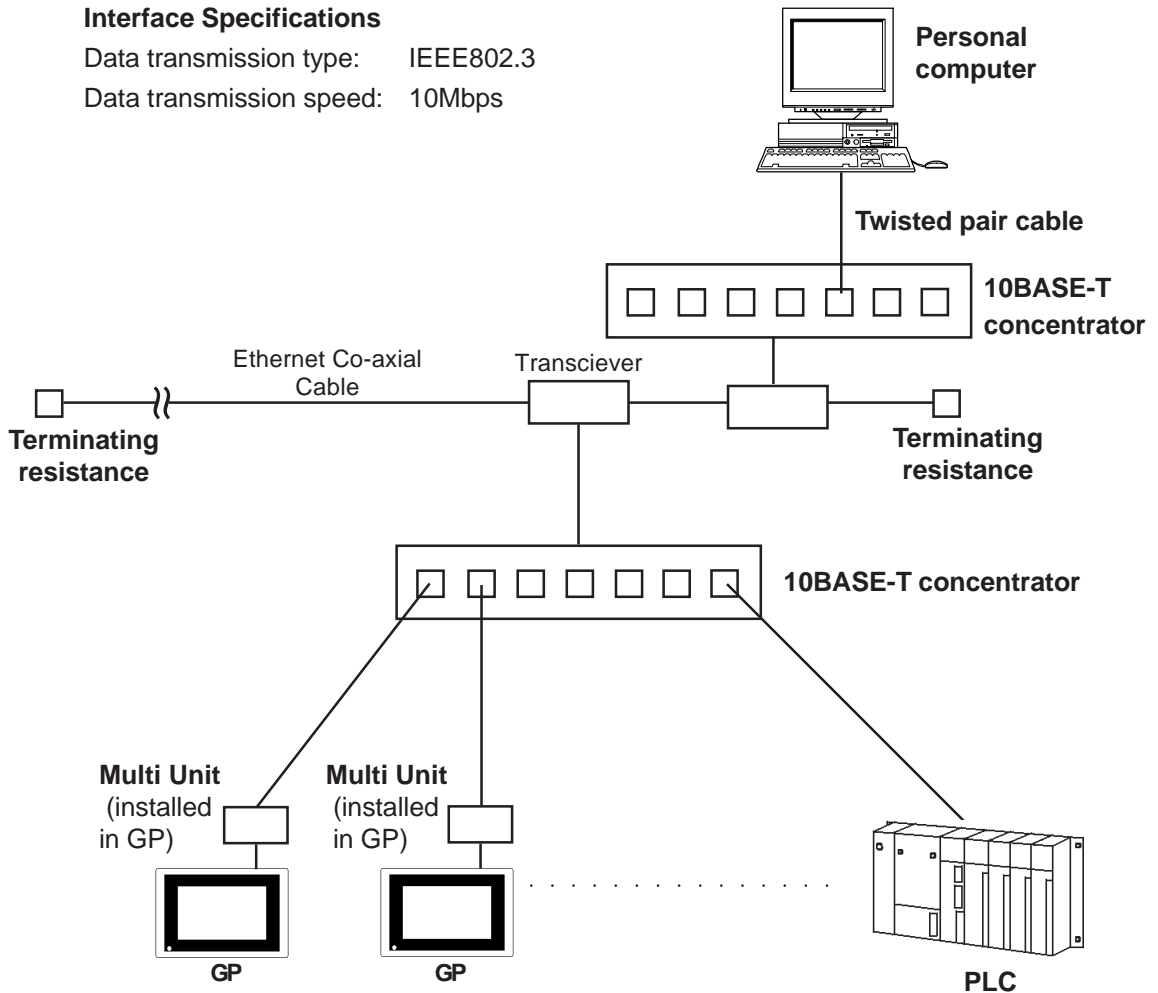

1.3.1 Screen Creation Software Settings

When the Multi Unit is being used with an Ethernet network, be sure to choose either the [Ethernet Compatible PLC], or [MultiLink Ethernet Type] for the screen creation software's [PLC Type] setting.

Also, when using the 2-Way Driver feature, after setting the [PLC type], be sure to also select the 2-Way Driver's [2-Way Ether] feature.

In both cases, be sure to also enter all necessary network information, such as IP addresses, etc.

For detailed information about these features refer to:

Reference *GP-PRO/PBIII for Windows Operation Manual* (included with screen creation software), *Pro-Server with Pro-Studio for Windows Operation Manual* (included with software)

Memo

Chapter

2 Specifications

1. Multi Unit Specifications
2. Interface Connector Specifications
3. Component Names and Functions
4. External Dimensions

This chapter describes the Multi Unit's specifications and component names, and shows the Multi Unit's external dimensions.

2.1 Multi Unit Specifications

2.1.1 General Specifications

Item	Description
Rated Voltage	DC5V \pm 5% (supplied from the GP)
Power Consumption	2.5W or less
Ambient Operating Temperature	0°C to 40°C (cannot exceed the GP's specified temperature range)
Ambient Operating Humidity	30 to 85%RH (cannot exceed the GP's specified humidity range)
Storage Temperature	-10°C to 60°C
Storage Humidity	30%RH to 85%RH (with no condensation)
Vibration Resistance (when installed in GP)	10Hz to 25Hz (19.6m/s ² in X, Y, Z directions for 30 minutes)
Atmosphere	Free of corrosive gasses
Grounding	100 Ω or less grounding resistance*1

*1 Or your country's applicable standard.

2.1.2 External Specifications

Item	Description
Usage	GP-377R Series expansion slot attachment unit
External Dimensions	107mm (4.21in.) <W> x 119mm (4.69in.) <H> x 31mm (1.22in.) <D> (Main unit, excluding projections)
Weight	Approximately 400g (881.1b) (without CF card)
Cooling Method	Natural air circulation

2.1.3 Interface Specifications

Item	Description
CF Card Interface	For CF card attachment: 1 slot ACCESS LED ACCESS switch
Printer Interface	Conforms to Centronics standards (Compatible with HP Laserjet PCL4 Commands, NEC PR201/PL Commands, EPSON ESC/P24-84, or equivalent) ^{*1}
10BASE-T Interface	Connector used: RJ-45 (8-pin modular jack) Input/output specifications: Conforms to IEEE802.3 Data transmission speed: 10Mbps Recommended cable: Conforms to IEEE802.3
External CF Card interface	CF Card Front Maintenance Unit connector

**1 Dedicated Windows printers cannot be used.*

2.2 Interface Connector Specifications

2.2.1 Printer Interface

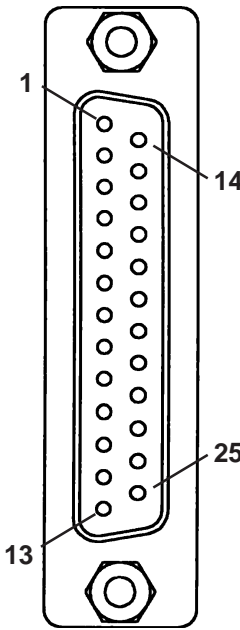
Pin Connection	Pin #	Signal Name
 <p>Jack screw: #4-40 (inch)</p>	1	PSTB
	2	PDB0
	3	PDB1
	4	PDB2
	5	PDB3
	6	PDB4
	7	PDB5
	8	PDB6
	9	PDB7
	10	NC
	11	BUSY
	12	NC
	13	NC
	14	NC
	15	NC
	16	$\overline{\text{INIT}}$
	17	NC
	18	GND
	19	GND
	20	GND
	21	GND
	22	GND
	23	GND
	24	GND
	25	GND

Recommended Connector: Dsub25pin plug XM2A-2501 <made by OMRON>

Recommended Cover : Dsub25pin Cover XM2S-2513<made by OMRON>

Jack Screws XM2Z-0073 <made by OMRON>

2.3 Component Names and Functions

This section describes each Multi Unit component's name and function.

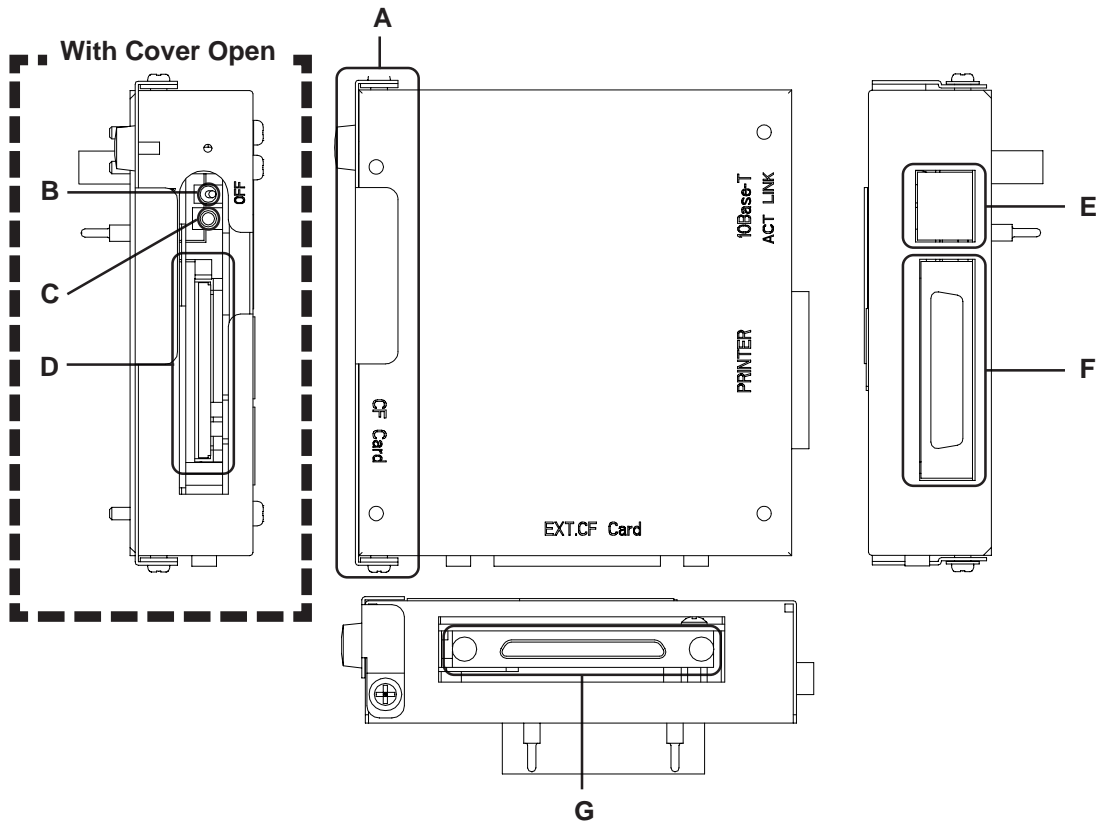

A: CF Card Maintenance Cover

The CF card interface is located inside this cover.

B: CF Card ACCESS Switch

When this switch is turned ON, access to the CF card is possible.

C: CF Card ACCESS LED

When the CF card ACCESS switch is turned ON, this LED lights.

When the ACCESS switch is turned OFF, this LED goes out. The LED is always lit while the CF card is being accessed.

D: CF Card*¹

CF Card Interface
CF card's insertion opening.

E: 10BASE-T I/F

Ethernet 10BASE-T interface.

ACT (orange)	When the power is ON: ON When sending data: Blinks
LINK (green)	When linked: ON When receiving data: Blinks

F: Printer I/F

Printer cable connection interface.

G: EXT. CF Card

CF card front maintenance unit connector

*1 When the CF Card Front Maintenance Unit is connected, the Multi Unit's CF Card Interface cannot be used.

2.4 External Dimensions

The Multi Unit's external dimensions are as follows:

Unit: mm (in.)



Top

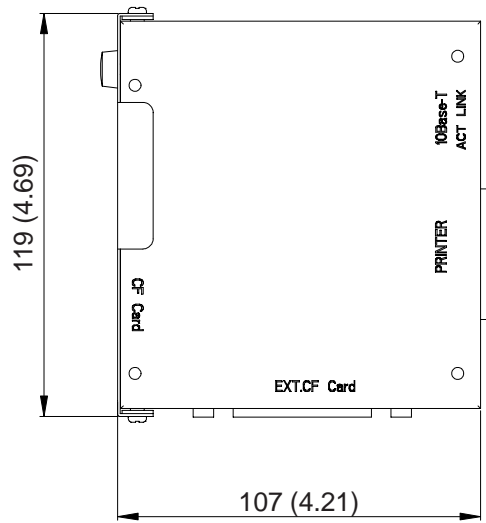

Front

When attached to the GP-377R

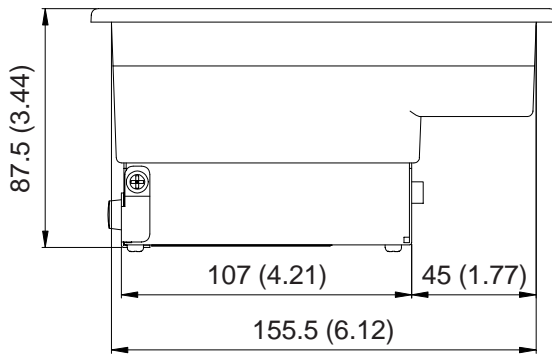

Top

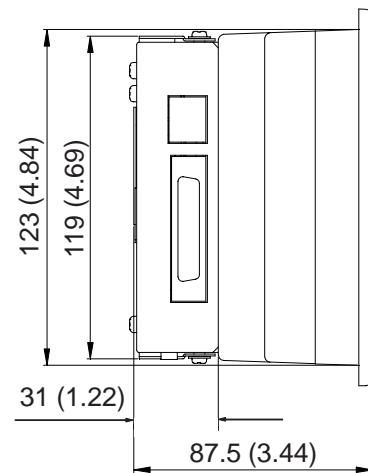

Side

Memo

Chapter

3 Installation and Setup

1. Installing the Multi Unit
2. CF Card Insertion and Removal
3. Printer Setup

This chapter describes Multi Unit installation, CF Card insertion and removal, and printer setup.

3.1 Installing the Multi Unit



WARNING

Prior to installing the Multi Unit, be sure to check that the GP's power is OFF. Otherwise, it can cause an electric shock.



Note: Prior to attaching the Multi Unit to the GP, be sure to connect the GP's power cord to the GP unit. The power cord cannot be attached to the GP after the Multi Unit is installed.

- ① Peel off the GP-377R expansion connector's seal.

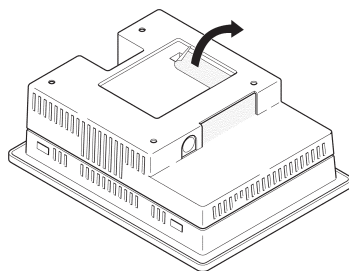

- ② Secure the Multi Unit in place with its four (4) attachment screws and their washers (see figure). A torque of only 0.5 to 0.6 N•m is needed.

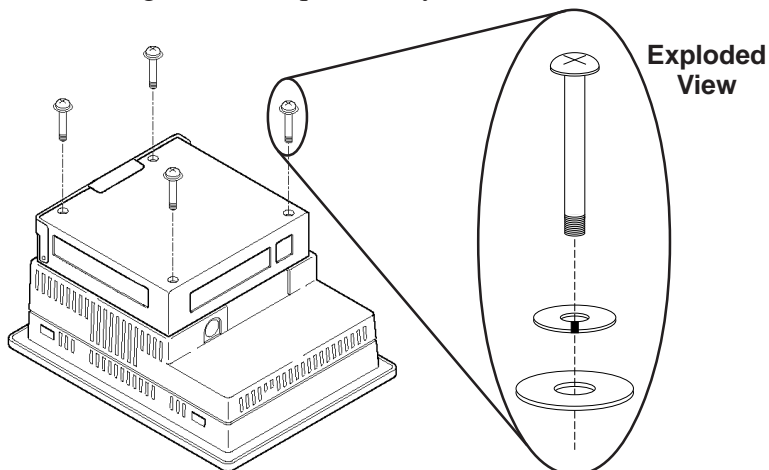

3.2 CF Card Insertion and Removal

CAUTIONS

When using the Multi Unit and a CF Card, follow the precautions below:

- Prior to inserting or removing a CF Card, be sure to turn the Multi Unit's CF Card ACCESS switch OFF and to confirm that the ACCESS lamp is not lit. If you do not, CF Card internal data may be damaged or lost.
- While a CF Card is being accessed, NEVER turn OFF or reset the GP, or insert or remove the CF Card. Prior to performing these operations, create and use a special GP application screen that will prevent access to the CF Card.

▼Reference▲ Refer to *GP-PRO/PB III for Windows Tag Reference Manual* (included in the screen editor software package)

- Prior to inserting a CF Card, familiarize yourself with the CF Card's front and rear face orientation, as well as the CF Card connector's position. If the CF Card is not correctly positioned when it is inserted into the Multi Unit, the CF Card's internal data and the Multi Unit may be damaged or broken.
- Be sure to use only CF Cards manufactured by the Digital Electronics Corporation. Multi Unit performance cannot be guaranteed when using another manufacturer's CF Card.
- Once GP data is lost, it cannot be recovered. Since accidental data loss can occur at any time, be sure to back up all GP screen and CF Card data regularly.

Chapter 3 - Installation and Setup

■ To Insert the CF Card

- ① Loosen the CF Card maintenance cover's attachment screw and open the cover.
- ② Turn the CF Card ACCESS switch OFF and confirm that the LED is not lit.
- ③ Confirm that the CF Card's orientation is correct, i.e. that the "CF Card" letters are face up and the small alignment triangle is in the top left corner.
- ④ Insert the CF card completely into the insertion slot, until the Eject Button is pushed outwards.
- ⑤ Turn the CF Card ACCESS switch ON.
- ⑥ Close the CF Card maintenance cover and tighten the cover's attachment screw.

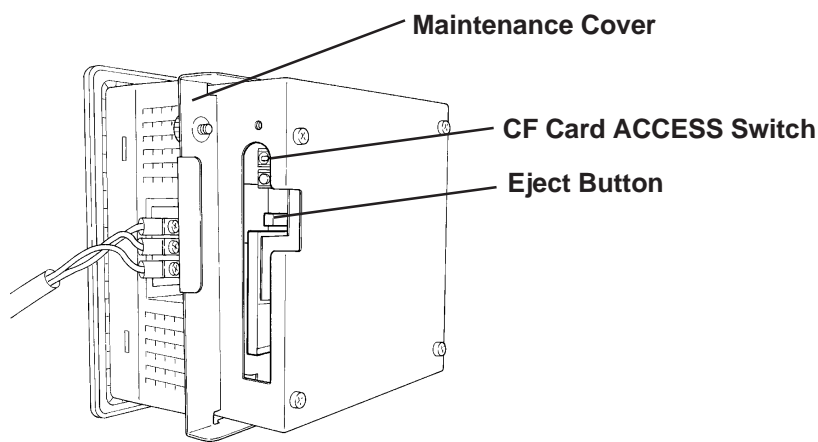

■ To Remove the CF Card

- ① Loosen the CF Card maintenance cover's attachment screw and open the cover.
- ② Turn the CF Card ACCESS switch OFF and confirm that the LED is not lit.
- ③ Press the Eject button.
- ④ Hold the middle of the CF Card and pull it out in a straight line. NEVER tilt it to one side.
- ⑤ Close the CF Card maintenance cover and tighten the cover's attachment screw.

3.3 Printer Setup

When a printer is connected to the Multi Unit, printer setup is performed via the GP's OFFLINE screen. On this screen, you can designate the printer type and printing formats.

Reference For the detailed information about the OFFLINE screen, refer to the *GP-377R User Manual*.

On the OFFLINE screen, change the tabs in the order of [MAIN]-> [INITIALIZE] -> [SET UP I/O] -> [PRINTER SETUP].

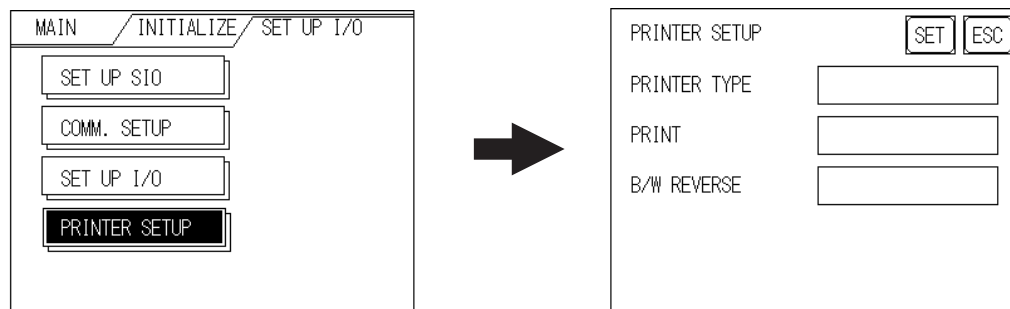

■ PRINTER TYPE

Select an appropriate printer model to be connected.

■ PRINT

Select either grey scale (monochrome) or color printing. Selecting grey scale means that the printing, blue and green, light blue and red, and purple and yellow will each be printed using the same pattern.



- Note:**
- HP Laser Jet Series printers do not support color printing. Be sure to select grey scale printing when using this printer.
 - When performing grey scale printing, the grey scale colors used will be reduced from the original 64 colors. Therefore, lightly shaded original colors cannot be printed, only darker colors.

Chapter 3 - Installation and Setup

■ B/W REVERSE

This setting switches a black attribute to a white attribute, and vice versa. When this attribute is enabled, and the GP's background color is black and the display color is white, the background will be print in white and the display will print in black.

<e.g.> When the GP's background color is black and the display color is white:

Enabled



Disabled



Note: This setting is effective only when printing out screen data. When printing other items, all data will be printed with a black background, regardless of this setting.

Memo

Chapter

4 CF Card

1. CF Card Handling
2. CF Card Initialization
3. Screen Data Backup

This chapter describes the precautions required when handling the CF Card, as well as the CF Card functions available when using the GP.

4.1 CF Card Handling



CAUTIONS

- **Be sure to use only CF Cards manufactured by the Digital Electronics Corporation. Multi Unit performance cannot be guaranteed when using another manufacturer's CF Card.**
- **Be sure to follow the instructions given below to prevent the CF Card's internal data from being destroyed or a CF Card malfunction from occurring:**
 - **DO NOT bend the CF Card.**
 - **DO NOT drop or strike the CF Card against another object.**
 - **Keep the CF Card dry.**
 - **DO NOT touch the CF Card or Multi Unit connectors.**
 - **DO NOT disassemble or modify the CF Card.**

The CF Card has a data overwrite limit of approximately 100,000 times. Therefore, be sure to back up all CF Card data regularly to another storage media. (100,000 times assumes the overwriting of 500KB of data in DOS format)

To view a CF Card's data on a personal computer, first, insert the CF Card into a CF Card Adapter. Then, insert the adapter into your personal computer's PC card slot. Depending on your model personal computer, the CF Card's data may not be able to be read correctly. Please contact your local GP distributor for a list of the latest CF Card and personal computer operation test results.

If your personal computer is not equipped with a PC card slot, please use a standard type PC Card or CF Card reader. All of Digital's CF Card operation testing has been performed using the following equipment.

Manufacturer Name	Model	Connection Type
I-O DATA DEVICE, INC.	CardDock-CF/P	Parallel port

The connection between a personal computer and CF Card reader has been tested using an IBM compatible machine. This does not mean, however, that any IBM compatible machine can be used. Please contact your PC or CF Card reader manufacturer directly for details.

4.2 CF Card Initialization

Here, the CF Card's initialization method is described. To perform initialization, however, the GP needs to have its system data downloaded from your PC via the screen editor software.

Be sure to use the following steps when initializing the CF Card.

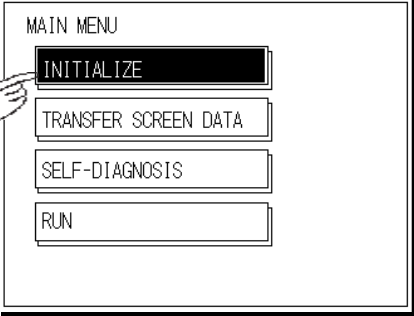
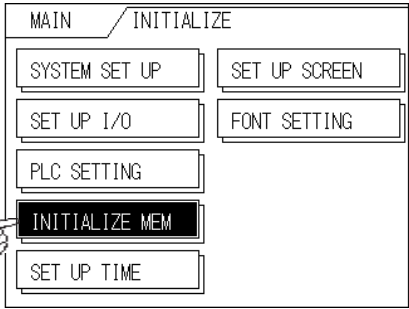
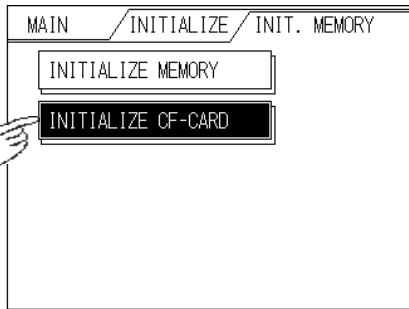
PROCEDURE	REMARKS
<p>① Select [INITIALIZE] from the GP OFFLINE mode's MAIN MENU.</p>  <p>The screenshot shows a 'MAIN MENU' with four options: 'INITIALIZE', 'TRANSFER SCREEN DATA', 'SELF-DIAGNOSIS', and 'RUN'. A hand icon points to the 'INITIALIZE' option, which is highlighted with a dark background.</p>	<p>Prior to starting operation, attach the Multi Unit to the GP and insert the CF Card into the Multi Unit.</p> <p>Reference For instructions on how to enter OFFLINE mode, refer to the <i>GP-377R Series User Manual</i> (sold separately).</p>
<p>② Select [INITIALIZE MEM]</p>  <p>The screenshot shows a menu titled 'MAIN / INITIALIZE' with seven options: 'SYSTEM SET UP', 'SET UP SCREEN', 'SET UP I/O', 'FONT SETTING', 'PLC SETTING', 'INITIALIZE MEM', and 'SET UP TIME'. A hand icon points to the 'INITIALIZE MEM' option, which is highlighted.</p>	
<p>③ Select [INITIALIZE CF-CARD].</p>  <p>The screenshot shows a menu titled 'MAIN / INITIALIZE / INIT. MEMORY' with two options: 'INITIALIZE MEMORY' and 'INITIALIZE CF-CARD'. A hand icon points to the 'INITIALIZE CF-CARD' option, which is highlighted.</p>	

PROCEDURE	REMARKS
<p>④ Enter the password using the numeric keys provided on the screen.</p> <div data-bbox="336 407 743 710" style="border: 1px solid black; padding: 5px; margin: 10px 0;"> <pre> INITIALIZE MEMORY WARNING : PREVIOUS DATA WILL BE OVERWRITTEN ! ENTER PASSWORD AND PRESS START KEY ? [] [START] </pre> </div> <p>⑤ Press the <input type="button" value="START"/> button, and the CF Card's initialization will start.</p> <p>⑥ When initialization is completed, the GP's display will return to the screen shown in step 3.</p>	<p>Enter the password registered in the screen editor software's [GP System Settings] screen, or in the GP's OFFLINE mode. If a password has not been registered yet, enter "1101".</p> <p>Reference Refer to <i>GP-PRO/PB III for Windows Operation Manual</i> (included in the screen editor software package) or each <i>GP's User Manual</i> (sold separately from the GP).</p>



Note: CF Card initialization erases all the data stored in the CF Card.

When the CF Card is initialized via the Mult Unit, a folder is created automatically. Data transferred to the CF Card is then stored in the following files.

Folder	Data Type	File Name
\file	Filing Data	ZF****.BIN
\log	Logging data	ZL****.CSV
\data	Image screen data	ZI****.BIN
	Sound data	ZO****.BIN
\mrm	GP backup data (MRM file)	ZC00001.MRM (fixed)
\trend	Trend graph data	ZT****.CSV
	Sampling data	ZS****.CSV
\alarm	Alarm data	
	- Active or Block 1 data	ZA****.CSV
	- History or Block 2 data	ZH****.CSV
	- Log or Block 3 data	ZG****.CSV



- CF Card data file names must be 8 characters or less. These file names, however, are not compatible with the FAT32 file naming system.
- When storing new data in a CF Card that will require the overwriting of old data, the CF Card's available capacity (free space) must be larger than the size of data to be stored, since the new data is written before the old data is deleted.

4.3 Screen Data Backup

Screen data backup can be performed using a CF Card backup file (*.MRM). This backup data can also be copied to another GP unit and used there.

This section explains how to back up data to the CF Card and how to copy screen data to a GP that has been previously setup, i.e. has had all its required system data sent to it via the screen editor software.

Only one (1) data file can be backed up to the CF Card at a time.

■ Backing Up a File to a CF Card (GP internal memory → CF Card)

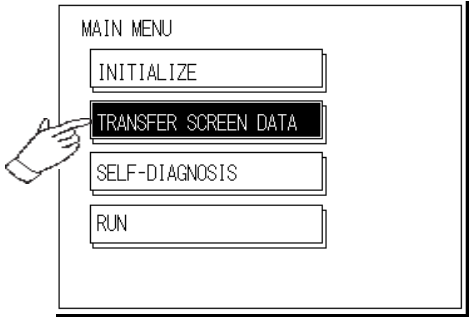
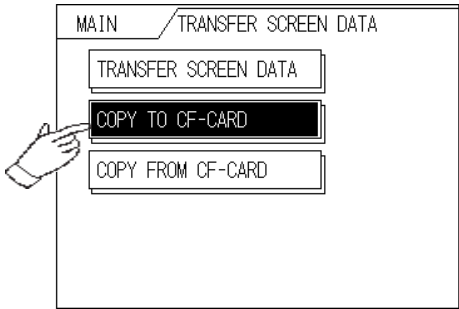
PROCEDURE	REMARKS
<p>① Select [TRANSFER SCREEN DATA] in the GP OFFLINE mode's MAIN MENU.</p>  <p>② Select [COPY TO CF-CARD]</p> 	<p>Before performing this procedure, be sure to attach the Multi Unit to the GP and insert the CF Card into the Multi Unit.</p> <p>▼ Reference ▼ To enter the GP OFFLINE mode, refer to GP-377R Series User Manual (sold separately).</p> <p>If the Multi Unit has not been attached to the GP, this menu will not appear.</p> <p>If a backup file (*.MRM) already exists in the CF Card, that data will be overwritten by your new data.</p>

PROCEDURE	REMARKS
<p>③ Use the screen's numeric keys to enter the password.</p> <div style="border: 1px solid black; padding: 10px; margin: 10px 0; width: fit-content;"> <p style="text-align: right;">ESC</p> <p>COPY TO CF-CARD</p> <p>WARNING! LOSING ALL CF-CARD DATA</p> <p>ENTER PASSWORD AND PRESS START KEY</p> <p>? <input style="width: 150px;" type="text"/></p> <p style="text-align: center;">START</p> </div> <p>④ Press the START button to start copying data to the CF Card.</p> <p>⑤ When copying is completed, the GP's display will return to the screen shown in step 2.</p>	<p>Be sure to enter the password registered in the screen editor software's [Screen Transfer] area. If a password has not been registered yet, enter "1101".</p> <p>▼Reference▲ Refer to <i>GP-PRO/PB III for Windows Operation Manual</i> (included in the screen editor software package)</p> <p>While data is being copied to the CF Card, DO NOT turn OFF or reset the GP.</p>

■ Copying a Backup File from the CF Card to the GP (CF Card → GP internal memory)

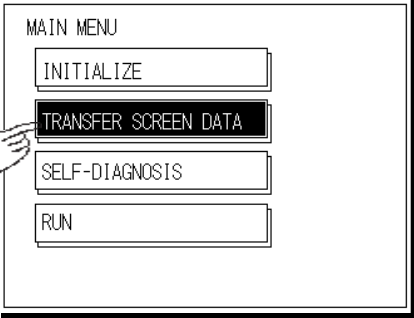
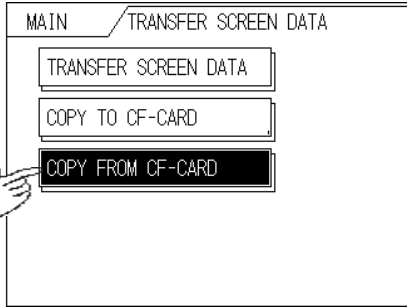
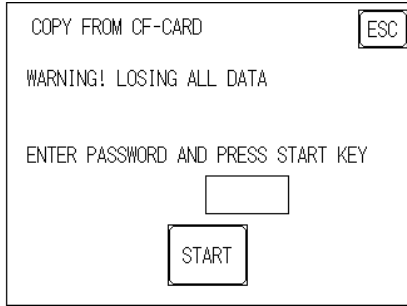
PROCEDURE	REMARKS
<p>① Select [TRANSFER SCREEN DATA] in the GP OFFLINE mode's MAIN MENU.</p>	<p>Prior to starting operation, install the Multi Unit in the rear of the GP and insert a CF Card into the Multi Unit.</p> <p>▼Reference▲ To enter the GP's OFFLINE mode, refer to GP-377R Series User Manual (sold separately).</p>
	
<p>② Select [COPY FROM CF-CARD].</p>	<p>When the [COPY FROM CF-CARD] is performed, data stored in the backup SRAM will be erased.</p> <p>If the protocol downloaded to the destination GP is different from the protocol for the file to be copied, an error message "Applicable PLC has not been set up" will appear. Be sure to only copy a backup file with the same protocol as the GP.</p>
	
<p>③ Enter the password using the GP screen's numeric keys.</p>	
	<p>Enter the password registered in the screen editor software's [GP System Settings] screen, or in the GP's OFFLINE mode. If a password has not been registered yet, enter "1101".</p>
<p>④ Press the <input type="button" value="START"/> button to start the copying of the data to the CF Card.</p>	<p>▼Reference▲ Refer to GP-PRO/PB III for Windows Operation Manual (contained in the screen editor software package) or GP-377R Series User Manual (sold separately).</p>
	<p>While data is being copied to the CF Card, DO NOT turn OFF or reset the GP.</p>

Memo

Chapter

5 Maintenance

1. Troubleshooting

2. Self-Diagnosis

This chapter describes the Multi Unit's maintenance procedures.

5.1 Troubleshooting

Here, only problems related to the Multi Unit are discussed.

Reference For Ethernet-related troubleshooting, refer to 5.1.1 Ethernet Troubleshooting.



WARNING

Prior to attaching or wiring the Multi Unit, confirm that both the GP and the Multi Unit power cords are disconnected from the main power supply. Otherwise, an electric shock may occur.

■ Multi Unit Problems and Countermeasures

Problem	Countermeasures
Cannot access the CF card	Check if the Multi Unit has been installed to the GP correctly.
	Check if the CF card has been inserted into the Multi Unit correctly.
	Check if the CF card ACCESS switch has been turned ON.
Cannot print	Check if the Multi Unit has been installed to the GP correctly.
	Check if the printer has been connected to the GP correctly.
	Check if the GP OFFLINE mode's printer settings are correct.

5.1.1 Ethernet Troubleshooting

If trouble occurs while data is being sent between the GP and the Host via the network, use the following flow chart to find the cause(s) of the problem.

Additionally, when an error message appears on the GP screen, be sure to make a note of the error code.

Reference Refer to *GP-377R Series User Manual* (sold separately).

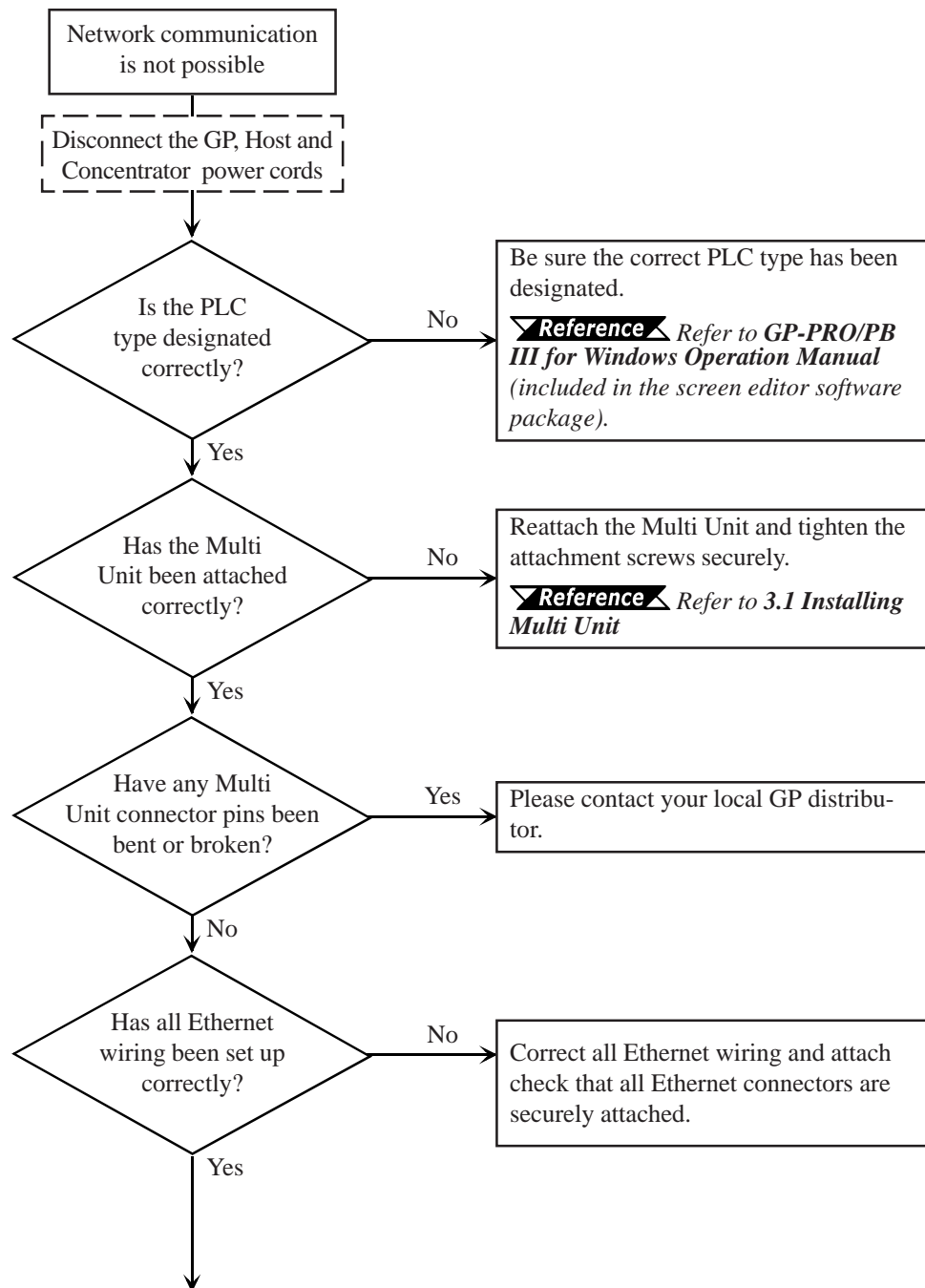

Chapter 5 - Maintenance

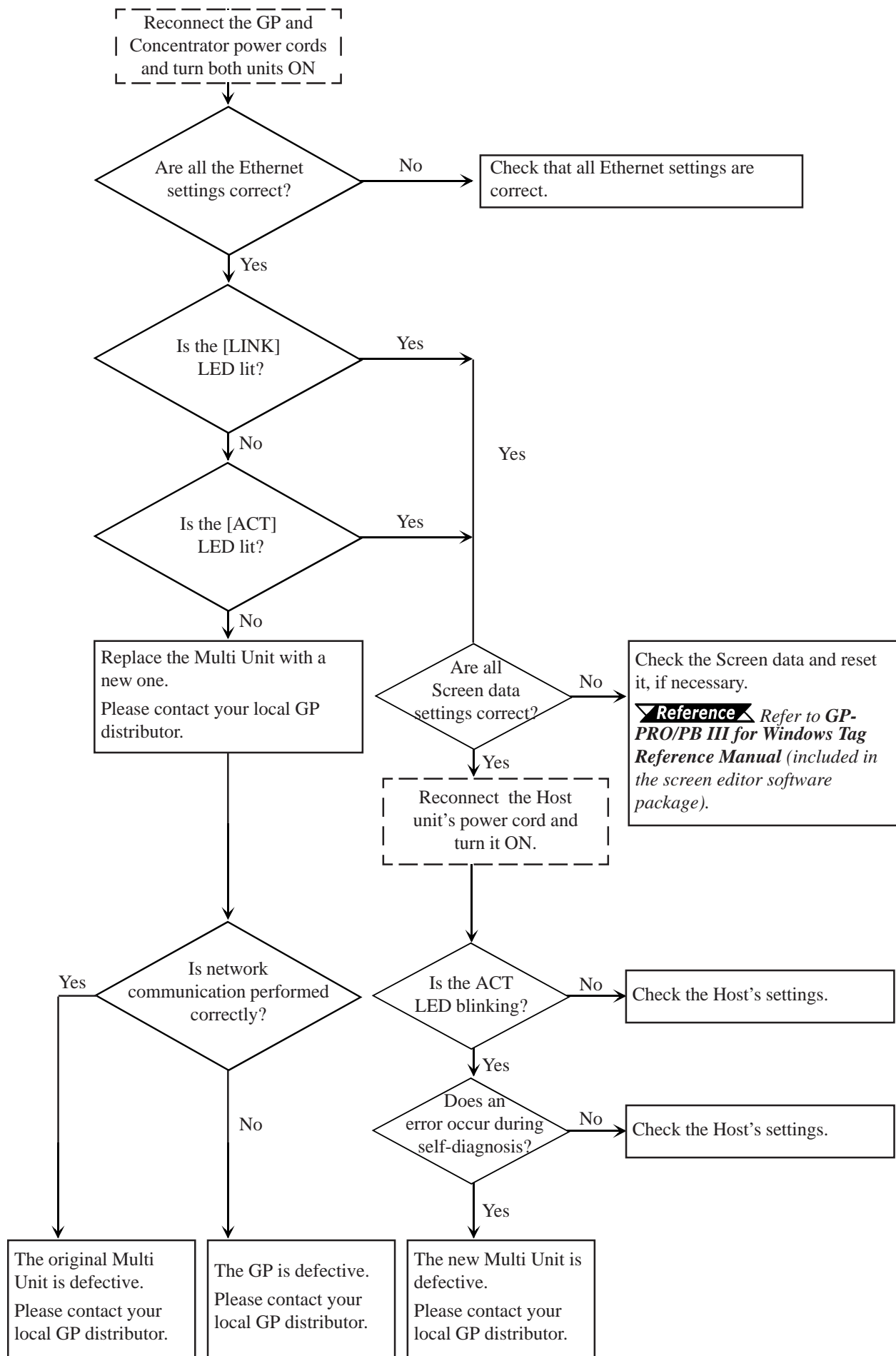

5.2 Self-Diagnosis

After the Multi Unit is installed in the rear of the GP, the Multi Unit self-diagnosis selection will be added to the GP OFFLINE mode's self-diagnosis menu. Here, self-diagnosis items related to the Multi Unit are described.

▼ **Reference** ▲ For the detailed information about the OFFLINE mode and the self-diagnosis feature, refer to the **GP-377R Series User Manual** (sold separately).

The Multi Unit's self-diagnosis includes the following items:

- Communication check (SIO CHECK)
- CF card check (CF-CARD CHECK)
- CF card check sum (CF-CARD CHECKSUM; inside CF-CARD CHECK)
- Printer interface check (PRINTER I/F)

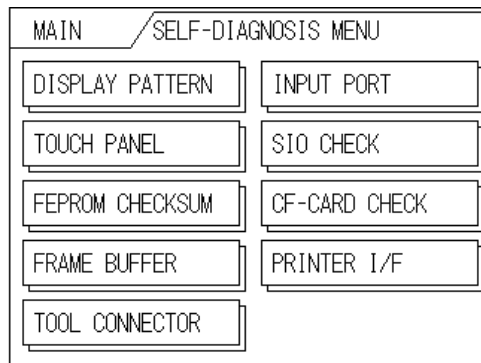

To display this screen, the GP needs to have system information sent to it via your PC's screen editor software. Items related to the Multi Unit will be displayed only after the Multi Unit is attached to the GP.

Chapter 5 - Maintenance

■ Communication Check

This feature checks if communication over the Ethernet network is being performed normally. To use this self-diagnosis feature, first connect a Concentrator and the Ethernet cable.

- ① Press the button in the [SELF-DIAGNOSIS MENU].
- ② If all communication conditions are normal, both “OK” and the ethernet address will display. If not, an error message will display.

■ CF Card Check

This feature checks the data read/write to the CF card. To perform this check a CF card is required, with more than 1KB of free space.

- ① Press the button in the [SELF-DIAGNOSIS MENU].
- ② Press the button in the [CF CARD] menu.
- ③ Confirm that the CF card has been inserted into the Multi Unit and press the button.
- ④ If the CF card’s data read/write feature is normal, “OK” will display. If not, an error message will display.

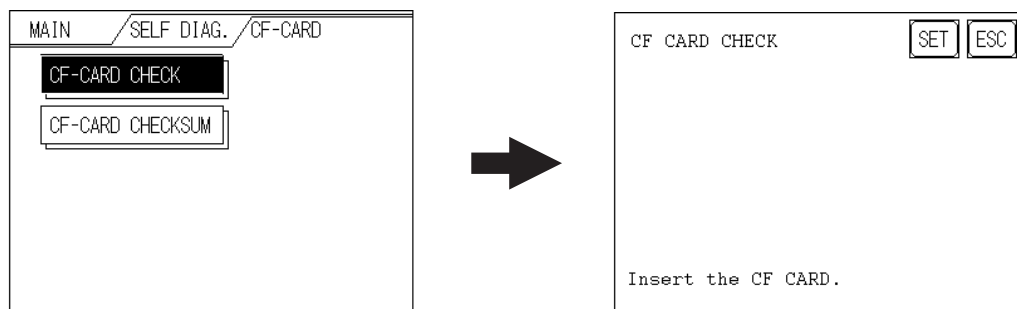

■ CF Card Check Sum

This uses the CF card file's check sum feature to check the CF card. To perform this check, a CF card must be inserted into the Multi Unit.

File types that can be checked are:

- Filing data
- CF card's image screen data
- CF card's sound data

- ① Press the button in the [SELF-DIAGNOSIS MENU].
- ② Press the button in the [CF CARD] menu.
- ③ Confirm that the CF card has been inserted into the Multi Unit and press the button.
- ④ After the check is completed, the number of checked files, number of error files, and the file name that last became an error will display.

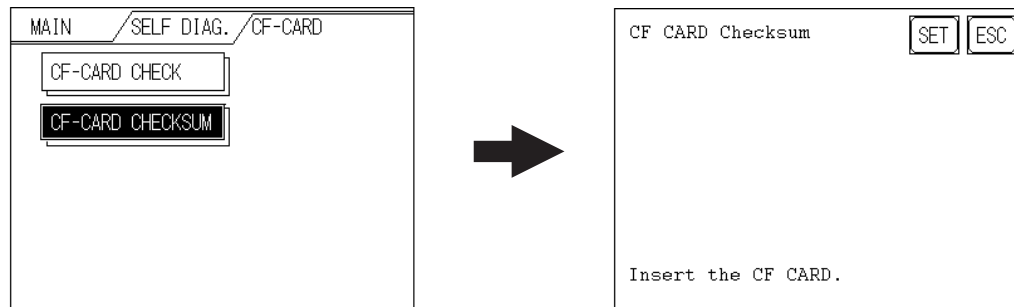

■ Printer Interface Check

This checks the printer interface. To perform this check, a printer cable must be attached to the Multi Unit's PRINTER connector.

- ① Press the button in the [SELF-DIAGNOSIS MENU].
- ② Confirm that the printer, printer cable and Multi Unit are all connected and press .
- ③ If the printer interface is operating normally, the characters "20h to 7D" and "A0h to DFh" will be printed and "OK" will appear on the screen. If not, an error message will appear.

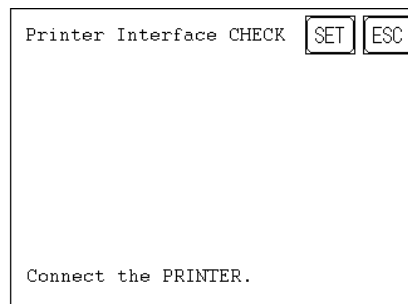

Index

Characters

10BASE-T E-i
10BASE-T concentrator E1-3
10BASE-T interface E1-1, E2-4
2-Way Driver E1-1, E1-3

A

ACCESS lamp E-v, E3-2
alignment triangle E3-3
Attachment Lock Washers E-vii
Attachment Washers E-vii
Attachment Screw E-vii, E3-1, E3-3
available capacity (free space) E4-4

B

B/W Reverse E3-5
Backing Up a File E4-5

C

CAUTIONS E-v, E3-2, E4-1
CD Card Front Maintenance Unit E1-2
CE Marking Notes E-vi
CF Card E-v, E-vii, E1-1, E2-4, E3-2, E4-4
CF Card ACCESS LED E2-4
CF Card ACCESS Switch E-v, E2-4
CF Card ACCESS switch OFF E3-2
CF Card Adapter E-vii, E1-2, E4-1
CF Card Check E5-5
CF Card Check Sum E5-6
CF Card Front Maintenance Unit E-vii
CF Card Handling E4-1
CF Card Initialization E4-3
CF Card Insertion E3-3
CF Card Insertion and Removal E3-2
CF Card Maintenance Cover E2-4
CF Card malfunction E4-1
CF Card reader E4-2
CF Card Removal E3-3
Communication Check E5-5
Compatible GP Units E-viii
Compatible Models E-viii
Compatible Software E-viii
Component Names and Functions E2-4

Copying E4-7

D

data copying E4-6
data file names E4-4
death or serious injury E-iv
Dedicated Windows printers E2-2
Documentation Conventions E-viii

E

electric shock E-iv, E3-1
error code E5-2
error message E4-7, E5-5, E5-6
Essential Safety Precautions E-iv
Ethernet Co-axial Cable E1-3
Ethernet connector E-i
Ethernet Troubleshooting E5-2
Ethernet-compatible PLC E1-1
Ethernet-related troubleshooting E5-1
EXT. CF Card E2-4
External Dimensions E2-5
External Specifications E2-1

F

FAT32 E4-4

G

General Specifications E2-1
GP data E3-2
grey scale printing E3-4

I

INITIALIZE E4-3
injury or damage to equipment E-iv
Installing the Multi Unit E3-1
Interface Specifications E2-2
Interface Connector Specifications E2-3
Interface Specifications E1-3

L

local GP distributor E4-1

M

Maintenance Cover	E3-3
Multi Unit connector	E4-1
Multi Unit Features	E1-1
Multi Unit Problems	E5-1
Multi Unit Specifications	E2-1
Multi Unit's internal circuit board	E-v
MultiLink Ethernet Type	E1-3

N

Network Configuration	E1-3
-----------------------------	------

O

OFFLINE	E1-2
ONLINE	E1-2
Optional Items	E-vii
overwrite limit	E4-1

P

Package Contents	E-vii
password	E4-6
power cord	E5-1
precautions	E-iv
Print	E3-4
Printer	E1-2
Printer Type	E3-4
Printer I/F	E2-4
Printer Interface Check	E5-6
Printer Setup	E3-4
Pro-face	E-i

R

Recommended Connector	E2-3
-----------------------------	------

S

Safety Precautions	E-iv
Screen Data Backup	E4-5
Self-Diagnosis	E5-4
System Configuration	E1-2

T

Tool Connector	E3-4
torque	E3-1
Troubleshooting	E5-1
Twisted pair cable	E1-3

U

UL/c-UL(CSA) Application Notes	E-vi
--------------------------------------	------

W

WARNING	E3-1
WARNINGS	E-iv, E5-1
washers	E3-1